



Dell™ Dimension™ 2200

[Technical Overview](#)
[Controls and Lights](#)
[Solving Problems](#)
[System Codes and Messages](#)
[Technical Specifications](#)
[System Setup Program](#)
[Adding and Replacing Parts](#)
[Documentation](#)

Hints, Notices, and Cautions

-  **HINT:** A HINT indicates important information that helps you make better use of your computer.
 -  **NOTICE:** A NOTICE indicates either potential damage to hardware or loss of data and tells you how to avoid the problem.
 -  **CAUTION:** A CAUTION indicates a potential for property damage, personal injury, or death.
-

Abbreviations and Acronyms

For a complete list of abbreviations and acronyms, see the [Tell Me How](#) help file.

Information in this document is subject to change without notice.
© 2002 Dell Computer Corporation. All rights reserved.

Reproduction in any manner whatsoever without the written permission of Dell Computer Corporation is strictly forbidden.

Trademarks used in this text: *Dell*, the *DELL* logo, and *Dimension* are trademarks of Dell Computer Corporation; *Intel* and *Celeron* are registered trademarks of Intel Corporation; *Microsoft* and *Windows* are registered trademarks of Microsoft Corporation; *Adobe* is a trademark of Adobe Systems Incorporated, which may be registered in certain jurisdictions.

Other trademarks and trade names may be used in this document to refer to either the entities claiming the marks and names or their products. Dell Computer Corporation disclaims any proprietary interest in trademarks and trade names other than its own.

This product incorporates copyright protection technology that is protected by method claims of certain U.S. patents and other intellectual property rights owned by Macrovision Corporation and other rights owners. Use of this copyright protection technology must be authorized by Macrovision Corporation, and is intended for home and other limited viewing uses only unless otherwise authorized by Macrovision Corporation. Reverse engineering or disassembly is prohibited.

September 2002 Rev. A02

System Codes and Messages

Dell™ Dimension™ 2200





- [Diagnostic Codes](#)
- [POST Beep Codes](#)
- [System Messages](#)

Diagnostic Codes

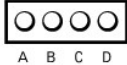
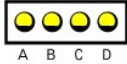
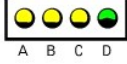
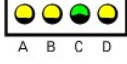
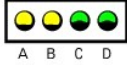
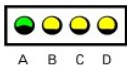
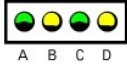
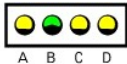
Your computer is equipped with four diagnostic lights, which are labeled "A," "B," "C," and "D" on the back of the computer. Each of the four lights can be yellow, green, or off as shown in the following table. When the computer is turned on or restarted and it is functioning normally, the lights flash during POST. After the computer starts, the lights remain green to signify normal computer operation.

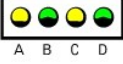
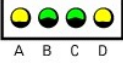
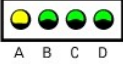
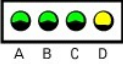
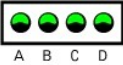
If a malfunction is detected and the computer fails to start, the lights display a code that identifies the problem. Write down the diagnostic code displayed and look it up in the following table.

Diagnostic Code	Definition	Corrective Action
	Power up default.	Make sure that the computer is connected to a known working electrical outlet, and then check whether the front-panel power light on the power button is on or off. If the power light is off, check the power supply. If the problem persists, see "Contacting Dell" in the <i>Owner's Manual</i> for instructions on obtaining technical assistance. See " Safety Instructions ," and then remove all cards . If the computer still does not start, see "Contacting Dell" in the <i>Owner's Manual</i> for instructions on obtaining technical assistance.
	System board is receiving power, but the BIOS is not executing.	Set the jumper PSWD to Maintenance mode, and restart the computer. Exit and save changes in the system setup program . Turn off the computer and reset the configuration jumper to Normal mode, and then restart the computer. See " Safety Instructions ," and then remove all cards and restart the computer to determine if a resource conflict exists. If a conflict exists, see " Resolving Software and Hardware Incompatibilities ." If the problem persists, see "Contacting Dell" in the <i>Owner's Manual</i> for instructions on obtaining technical assistance.
	Recovery mode from BIOS failure.	Set the jumper PSWD to Maintenance mode and restart the computer. Exit and save changes in the system setup program . Turn off the computer and reset the configuration jumper to Normal mode, and then restart the computer. See " Safety Instructions ," and then remove all cards and restart the computer to determine if a resource conflict exists. If a conflict exists, see " Resolving Software and Hardware Incompatibilities ." If the problem persists, see "Contacting Dell" in the <i>Owner's Manual</i> for instructions on obtaining technical assistance.
	Microprocessor has failed a BIOS test.	If the problem persists, see "Contacting Dell" in the <i>Owner's Manual</i> for instructions on obtaining technical assistance.
	Memory failed to be sized or enabled.	Reset the memory modules . If the problem persists, see "Contacting Dell" in the <i>Owner's Manual</i> for instructions on obtaining technical assistance.
	No memory modules are detected.	<ol style="list-style-type: none"> 1 Reset all memory modules, and then restart the computer. 1 To eliminate the possibility of a faulty memory connector, remove all memory modules, reinstall one memory module (if the computer supports a single module), and then restart the computer. If the computer starts normally, move the memory module to a different connector and restart the computer. Continue until you have identified a faulty connector or reinstalled all modules without error. <p>If the problem persists, see "Contacting Dell" in the <i>Dell Owner's Manual</i> for instructions on obtaining technical assistance.</p>
	Memory modules are detected, but a memory configuration or compatibility error exists.	<ol style="list-style-type: none"> 1 Be sure that there are no special memory module/memory connector placement requirements. 1 Verify that the memory modules that you are installing are compatible with the computer. <p>If the problem persists, see "Contacting Dell" in the <i>Dell Owner's Manual</i> for instructions on obtaining technical assistance.</p>
	PCI bus failure has occurred.	See " Safety Instructions ," and then remove all cards and restart the computer to determine if a resource conflict exists. If conflict exists, see Resolving Software and Hardware Incompatibilities . If the problem still persists, see "Contacting Dell" in the <i>Owner's Manual</i> for instructions on obtaining technical assistance.
	Video controller failed to initialize or respond.	See "Contacting Dell" in the <i>Owner's Manual</i> for instructions on obtaining technical assistance.

		
	IDE bus failure has occurred.	Reseat the drive cables. If the problem persists, see "Contacting Dell" in the <i>Owner's Manual</i> for instructions on obtaining technical assistance.
	USB port or a device connected to it has failed initialization.	Disconnect the device from the USB connector . If the problem persists, see "Contacting Dell" in the <i>Owner's Manual</i> for instructions on obtaining technical assistance.
	Other failure.	See "Contacting Dell" in the <i>Owner's Manual</i> for instructions on obtaining technical assistance.
	Computer has started and turned over control to the operating system.	No action is necessary.
<p>  = yellow  = green  = off </p>		

POST Beep Codes

If the monitor cannot display errors or problems, during POST the computer might emit a series of beeps, or beep code, that identifies the problem. The POST beep codes are listed below.

Beep Codes	Possible Cause	Corrective Action
1	A memory refresh failure occurred.	Reseat the memory modules.
2	Memory parity cannot be reset.	Reseat the memory modules.
3	A failure occurred in the first 64 KB of memory.	Reseat the memory modules.
4	The system timer is not operational.	See "Contacting Dell" in the <i>Owner's Manual</i> for instructions on obtaining technical assistance.
6	8042 Gate A20 cannot be toggled.	See "Contacting Dell" in the <i>Owner's Manual</i> for instructions on obtaining technical assistance.
7	An exception interrupt error occurred.	See "Contacting Dell" in the <i>Owner's Manual</i> for instructions on obtaining technical assistance.
8	A read/write error occurred in the display memory.	See "Contacting Dell" in the <i>Owner's Manual</i> for instructions on obtaining technical assistance.
10	A CMOS shutdown register test error occurred.	See "Contacting Dell" in the <i>Owner's Manual</i> for instructions on obtaining technical assistance.
11	An invalid BIOS is installed.	See "Contacting Dell" in the <i>Owner's Manual</i> for instructions on obtaining technical assistance.

System Messages

Message	Possible Cause	Corrective Action
8042 Gate-A20 error	The keyboard controller failed its test.	If you receive this message after making changes in the system setup program , enter the program and restore the original value(s).
Address Line Short!	Error in the address decoding circuitry in the memory.	Reseat the memory modules.
C: Drive Error C: Drive Failure	The hard drive is not working or is not configured correctly.	Ensure that the drive is installed correctly in the computer and defined correctly in the system setup program .
Cache Memory Bad, Do Not Enable Cache	Cache memory is not operating.	See "Contacting Dell" in the <i>Owner's Manual</i> for instructions on obtaining technical assistance.

CH-2 Timer Error	An error is occurring on the timer on the system board.	See "Contacting Dell" in the <i>Owner's Manual</i> for instructions on obtaining technical assistance.
CMOS Battery State Low CMOS Checksum Failure CMOS System Options Not Set CMOS Display Type Mismatch CMOS Memory Size Mismatch CMOS Time and Date Not Set	The system configuration information in the system setup program is incorrect, or the battery charge may be low.	Enter the system setup program and verify the system configuration; then restart the computer.
Diskette Boot Failure	Drive A or B is present but has failed the BIOS POST.	Ensure that the drive is installed correctly in the computer and defined correctly in the system setup program . Check the interface cable at both ends.
DMA Error DMA 1 Error DMA 2 Error	Error in the DMA controller on the system board.	The keyboard or system board may need to be replaced.
FDD Controller Failure HDD Controller Failure	BIOS cannot communicate with the floppy drive or hard drive controller.	Ensure that the floppy drive or the hard drive is installed correctly in the computer and defined correctly in the system setup program . Check the interface cable at both ends.
INTR1 Error INTR2 Error	Interrupt channel on the system board failed to POST.	The keyboard or system board may need to be replaced.
Invalid Boot Diskette	The operating system cannot be located on drive A or drive C.	Enter the system setup program and confirm that drive A or drive C is properly identified.
Keyboard Error	The BIOS has detected a stuck key.	Make sure that nothing is resting on the keyboard; if a key appears to be stuck, carefully pry it up. If the problem persists, you may need to replace the keyboard.
KB/Interface Error	An error occurred with the keyboard connector.	Make sure that nothing is resting on the keyboard; if a key appears to be stuck, carefully pry it up. If the problem persists, you may need to replace the keyboard.
No ROM Basic	The operating system cannot be located on drive A or drive C.	Enter the system setup program and confirm that drive A or drive C is properly identified.

[Back to Contents Page](#)

[Back to Contents Page](#)

Documentation

Dell™ Dimension™ 2200

- [Printed Documentation](#)
 - [Online Documentation](#)
-

Printed Documentation

 **HINT:** You must right-click the link for a PDF file and save the file to your hard drive. Attempting to open large PDF files through your browser causes your system to freeze.

To save PDF files (files with an extension of **.pdf**) to your hard drive, right-click the document title, click **Save Target As** in Microsoft® Internet Explorer or **Save Link As** in Netscape Navigator, and specify a location on your hard drive.

Right-click only the following links:

[Dell Dimension 2200 Owner's Manual \(.pdf\) \(1.51 MB\)](#) — Provides information on adding upgrades, performing basic troubleshooting procedures, and reinstalling drivers. It also provides technical specifications.

 **HINT:** PDF files require Adobe™ Acrobat Reader, which can be downloaded from the Adobe World Wide Web site at <http://www.adobe.com/acrobat/>. To view a PDF file, launch Acrobat Reader. Click **File**—> **Open** and select the PDF file.

Online Documentation

The *Tell Me How* help file is already loaded on your hard drive when you receive your computer. To open the file, click the **Start** button on the Windows® desktop, point to **Programs**—> **User's Guides**, and then click **Tell Me How**.

 **HINT:** *Tell Me How* help files (files with an extension of **.chm**) require Microsoft Internet Explorer 4.0 or later.

The *Tell Me How* help file allows you to search for information in multiple ways. You can quickly link to information on the following topics:

- 1 Hardware and software features of your computer
- 1 The Windows desktop, where you can change your wallpaper and screen saver, create shortcuts, and position icons
- 1 Software access, installation, and removal
- 1 Basic file management, such as finding, copying, deleting, and renaming files
- 1 Tips on using your computer hardware

Downloading the *Tell Me How* Help File and Associated Files

1. Right-click the following link to the **hhactivex.dll** file: [hhactivex.dll](#).
2. Click **Save Target As** in Microsoft Internet Explorer or **Save Link As** in Netscape Navigator, and specify **c:\windows\system**.
3. Click the **Start** button on the Microsoft Windows desktop, and then click **Run**.
4. Type `regsvr32 hhactivex.dll` and then press <Enter>.
5. Click **OK** when the installation is complete.
6. Right-click the following link to the file: [Dell Dimension 2200 Tell Me How \(.chm\) \(1.0 MB\)](#).
7. Click **Save Target As** in Microsoft Internet Explorer or **Save Link As** in Netscape Navigator, and specify a location on your hard drive.

Viewing the *Tell Me How* Help File

1. Click the **Start** button on the Windows desktop, point to **Programs**, and then click **Windows Explorer**.
 2. Navigate to the directory in which you saved the *Tell Me How* help file.
 3. Double-click the file (**tellhow.chm**).
-

[Back to Contents Page](#)

[Back to Contents Page](#)

Adding and Replacing Parts

Dell™ Dimension™ 2200

- [Safety Instructions](#)
- [Shutting Down the Computer](#)
- [Removing the Computer Cover](#)
- [Looking Inside Your Computer](#)
- [Rotating the Power Supply](#)
- [Front Panel](#)
- [3.5-Inch Front-Panel Insert](#)
- [Upper 3.5-Inch Drive](#)
- [Lower 3.5-Inch Floppy Drive](#)
- [5.25-Inch Drive](#)
- [Hard Drive](#)
- [Power Supply and Fan Assembly](#)
- [Control Panel](#)
- [Adding or Removing Cards](#)
- [Adding Memory](#)
- [Replacing the Battery](#)
- [Replacing the Microprocessor](#)
- [Replacing the System Board](#)
- [Replacing the Computer Cover](#)

Safety Instructions

As you use your computer, observe the following safe-handling guidelines. For comfort and efficiency, observe the ergonomic guidelines provided in "Sitting Comfortably at Your Computer" in the *Tell Me How* help file.

When Using Your Computer

⚠ CAUTION: Do not operate your computer with any cover(s) (including the computer cover, filler brackets, front-panel inserts, and so on) removed.

- 1 Your computer is equipped with either an auto-sensing voltage selector or a manual voltage-selection switch. Computers with an auto-sensing voltage selector do not have a voltage-selection switch on the back panel and automatically detect the correct operating voltage. Computers with a voltage-selection switch on the back panel must be manually set to operate at the correct operating voltage. To help avoid damaging a computer with a manual voltage-selection switch, be sure that the voltage-selection switch is set to match the AC power available at your location:

- o 115 V/60 Hz in most of North and South America and some Far Eastern countries such as South Korea and Taiwan
- o 100 V/50 Hz in eastern Japan and 100 V/60 Hz in western Japan

🔧 NOTE: The voltage selection switch must be set to the 115V position even though the AC supply in Japan is 100 V.

- o 230 V/50 Hz in most of Europe, the Middle East, and the Far East

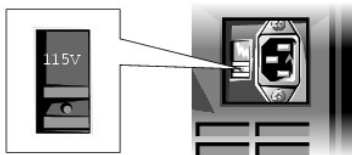

Also be sure that your monitor and attached devices are electrically rated to operate with the AC power available in your location.

- 1 To help prevent damage to your computer when disconnecting a network cable from your computer, first unplug the cable from the computer network connector and then from the network wall jack. When reconnecting a network cable to your computer, first plug the network cable into the network wall jack and then into the computer network connector.
- 1 To help avoid possible damage to the system board, wait 5 seconds after turning off the computer before disconnecting or connecting a non-USB device.
- 1 To help prevent electric shock, plug the computer and device power cables into properly grounded power sources. These cables are equipped with 3-prong plugs to help ensure proper grounding. Do not use adapter plugs or remove the grounding prong from a cable. If you must use an extension cable, use a 3-wire cable with properly grounded plugs.
- 1 To help protect your computer from sudden, transient increases and decreases in electrical power, use a surge suppressor, line conditioner, or uninterruptible power supply.
- 1 Be sure that nothing rests on your computer cables and that the cables are not located where they can be stepped on or tripped over.
- 1 Do not spill food or liquids on your computer. If the computer gets wet, contact Dell.
- 1 Do not push any objects into the openings of your computer. Doing so can cause fire or electric shock by shorting out interior components.
- 1 Keep your computer away from radiators and heat sources. Also, do not block cooling vents. Avoid placing loose papers underneath your computer; do not place your computer in a closed-in wall unit or on a bed, sofa, or rug.

When Working Inside Your Computer

Before you open the computer cover, perform the following steps in the sequence indicated.

➡ NOTICE: Do not attempt to service the computer yourself, except as explained in this guide and elsewhere in Dell™ documentation. Always follow installation and service instructions closely.

1. Turn off your computer and all devices.
2. Ground yourself by touching an unpainted metal surface at the back of the computer before touching anything inside your computer.

While you work, periodically touch an unpainted metal surface on the computer to dissipate any static electricity that might harm internal components.

3. Disconnect any devices connected to the computer, including the monitor, from their electrical outlets to reduce the potential for personal injury or shock. Also, disconnect any telephone or telecommunication lines from the computer.
4. Disconnect the power cable from your computer, and then press the power button to ground the system board.

In addition, take note of these safety guidelines when appropriate:

- 1 When you disconnect a cable, pull on its connector, not on the cable itself. As you pull connectors apart, keep them evenly aligned to avoid bending any pins. Also, before you connect a cable, make sure that both connectors are correctly oriented and aligned.
- 1 Handle components and cards with care. Don't touch the components on a card. Hold a card by its edges or by its metal bracket.

 **CAUTION:** There is a danger of a new battery exploding if it is incorrectly installed. Replace the battery only with the same or equivalent type recommended by the manufacturer. Discard used batteries according to the manufacturer instructions.

Protecting Against Electrostatic Discharge

To prevent static damage, discharge static electricity from your body before you touch anything inside your computer and periodically while you work inside the computer. You can do so by touching an unpainted metal surface on the back of the computer.

You can also take the following steps to prevent static damage:

- 1 Do not remove items from their antistatic packing material until you are ready to install them in your computer. Just before unwrapping the antistatic packaging, be sure to discharge static electricity from your body.
- 1 When transporting a sensitive component, first place it in an antistatic container or packaging.

Shutting Down the Computer

 **NOTICE:** To prevent data loss, you must turn off your computer through the **Start** menu rather than by pressing the power button.

 **HINT:** If you are having difficulty turning off your computer, see "[General Program Problems](#)."

Microsoft® Windows® XP

1. Save and close any open files and exit any open programs.
2. Click the **Start** button and then click **Turn off Computer**.
3. Click **Turn off**.

The computer automatically turns off after the shutdown process finishes.

4. Turn off your monitor and any other devices connected to power.

Windows 2000

1. Save and exit any programs and files you have open.
2. Click the **Start** button, and then click **Shut Down**.
3. Click the pull-down menu under **What do you want the computer to do?**
4. Click **Shut down** and then click **OK**.

The computer automatically turns off after the shutdown process finishes.

5. Turn off your monitor and any other devices connected to power.

Removing the Computer Cover

 **CAUTION:** Before you begin any of the procedures in this section, follow the safety instructions in "[Safety Instructions](#)."

 **CAUTION:** To guard against electrical shock, always unplug your computer from the electrical outlet before opening the cover.

1. [Shut down the computer](#).
2. Turn off any attached devices and disconnect them from their electrical outlets.

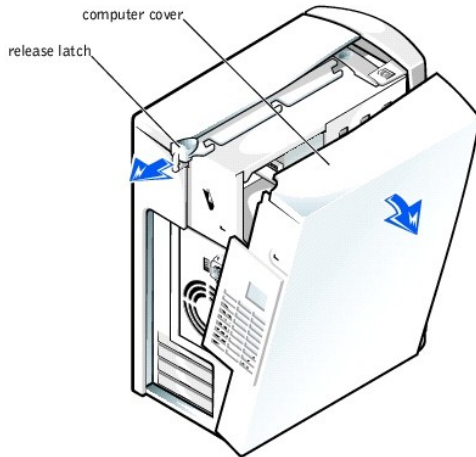

 **NOTICE:** To disconnect a network cable, first unplug the cable from your computer and then unplug it from the network wall jack.

3. Disconnect the computer power cable from the wall outlet, and then press the power button to ground the system board.
4. Open the cover:
 - a. Face the front of the computer.
 - b. Place your left hand on the left side of the computer.
 - c. Push back the release latch at the top back edge of the computer to release the computer cover into your left hand.





5. Lift the cover out from the curved hinge at the bottom of the computer.
-

Looking Inside Your Computer

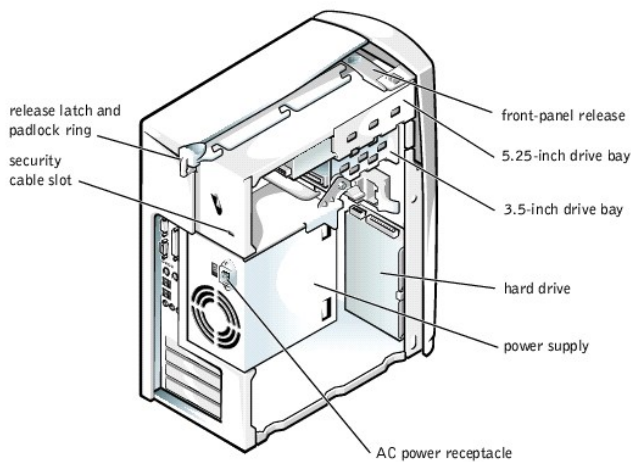
-  **CAUTION:** Before you begin any of the procedures in this section, follow the safety instructions in "[Safety Instructions](#)."
-  **CAUTION:** To guard against electrical shock, always unplug your computer from the electrical outlet before opening the cover.
-  **NOTICE:** Be careful when you open the computer cover to ensure that you do not inadvertently disconnect cables from the system board.



Rotating the Power Supply

-  **CAUTION:** Before you begin any of the procedures in this section, follow the safety instructions in "[Safety Instructions](#)."
-  **CAUTION:** To guard against electrical shock, always unplug your computer from the electrical outlet before opening the cover.

1. [Shut down the computer.](#)
2. Turn off any attached devices and disconnect them from their electrical outlets.

🔔 **NOTICE:** To disconnect a network cable, first unplug the cable from your computer and then unplug it from the network wall jack.

3. Disconnect the computer power cable from the wall outlet, and then press the power button to ground the system board.
4. [Remove the computer cover.](#)
5. Lay the computer on its side as shown in the following illustration.

Press the release latch while lifting the power supply. Rotate the power supply out of the computer while keeping the drive power cables clear.

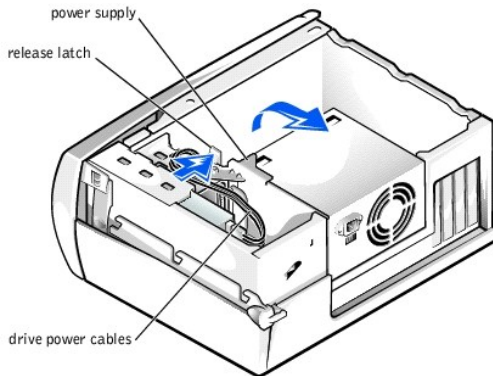

When you rotate the power supply back into the computer, gently lift the and hold the drive cables out of the way. Rotate the power supply into position until its release latch clicks. Lay the drive power cables along the top of the latch.

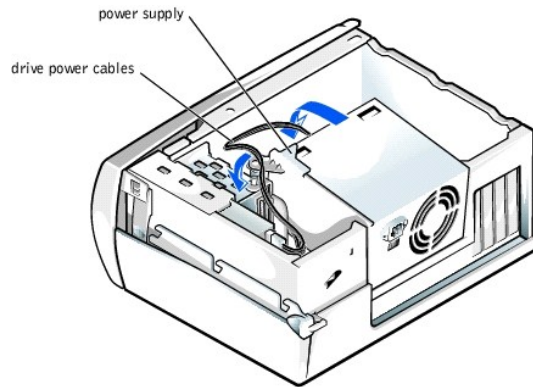

Front Panel

- ⚠️ **CAUTION:** Before you begin any of the procedures in this section, follow the safety instructions in "[Safety Instructions.](#)"
- ⚠️ **CAUTION:** To guard against electrical shock, always unplug your computer from the electrical outlet before opening the cover.

1. [Shut down the computer.](#)
2. Turn off any attached devices and disconnect them from their electrical outlets.

🔔 **NOTICE:** To disconnect a network cable, first unplug the cable from your computer and then unplug it from the network wall jack.

3. Disconnect the computer power cable from the wall outlet, and then press the power button to ground the system board.
4. [Remove the computer cover.](#)

5. While facing the front of the computer, press in the front-panel release tab at the top of the computer.

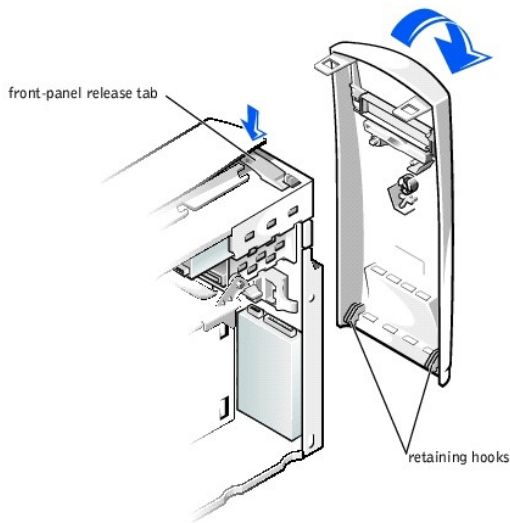

6. Swing the front panel away from the computer, disengage the two retaining hooks at the bottom of the front panel, and carefully pull it away from the computer.
7. To replace the front panel, fit the two front-panel retaining hooks into their corresponding slots on the computer frame. Rotate the front panel toward the computer until the front panel latches into position.

3.5-Inch Front-Panel Insert

⚠ CAUTION: Before you begin any of the procedures in this section, follow the safety instructions in "[Safety Instructions](#)."

⚠ CAUTION: To guard against electrical shock, always unplug your computer from the electrical outlet before opening the cover.

1. [Shut down the computer](#).

2. Turn off any attached devices and disconnect them from their electrical outlets.

🔗 NOTICE: To disconnect a network cable, first unplug the cable from your computer and then unplug it from the network wall jack.

3. Disconnect the computer power cable from the wall outlet, and then press the power button to ground the system board.

4. [Remove the computer cover](#).

5. [Remove the front panel](#).

6. From the back of the front panel, press the release tab to the side.

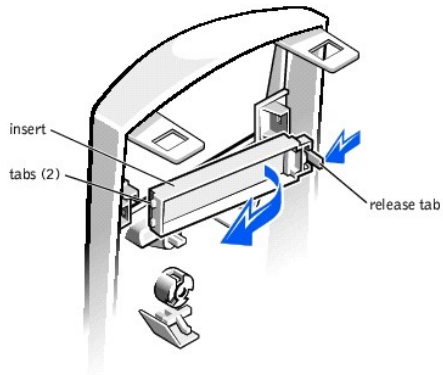

7. Rotate the insert toward you, and remove it from the front panel.

If you permanently remove a drive from the drive cage, replace the front-panel insert by inserting its two tabs into the slot in the front panel and rotating the insert forward until it snaps into place.

Upper 3.5-Inch Drive

⚠ CAUTION: Before you begin any of the procedures in this section, follow the safety instructions in "[Safety Instructions](#)."

⚠ CAUTION: To guard against electrical shock, always unplug your computer from the electrical outlet before opening the cover.

1. [Shut down the computer](#).
2. Turn off any attached devices and disconnect them from their electrical outlets.

🔍 NOTICE: To disconnect a network cable, first unplug the cable from your computer and then unplug it from the network wall jack.

3. Disconnect the computer power cable from the wall outlet, and then press the power button to ground the system board.
4. [Remove the computer cover](#).
5. [Remove the front panel](#).
6. [Rotate the power supply](#) away from the system board.
7. Remove the metal drive bay plate covering the bay.

Using a screwdriver, pop out the metal plate from the left or right side of the computer.

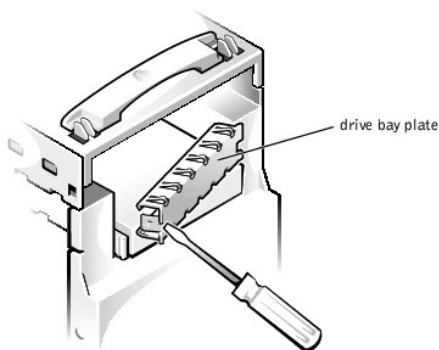

8. Remove the extra rails from the front of the computer frame.
9. Install the rail marked "L" on the left side of the drive and the rail marked "R" on the right side of the drive.

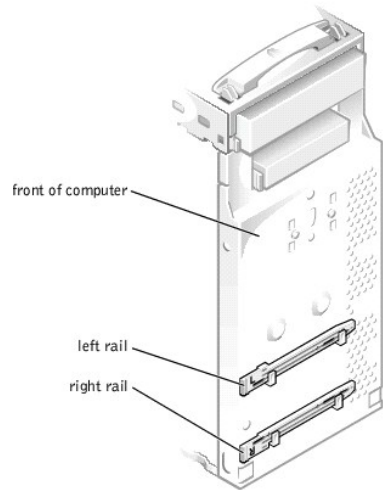

10. Slide the drive assembly into the drive bay.

➡ **NOTICE:** Dell does not recommend routing cables over cards because the cables can restrict airflow, cause cooling problems, and interfere with removing and replacing the computer cover. If you must route cables over cards, be extremely cautious when removing and replacing the computer cover.

11. If you are installing a controller card, configure and [install it in a connector slot](#) now.

Install the card as close as you can to the drive cage.

12. Connect a power cable to the drive.

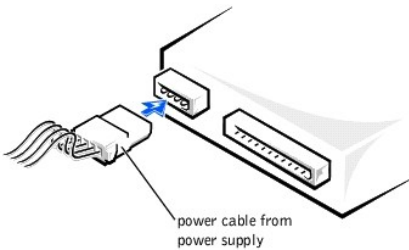

➡ **NOTICE:** When you attach the extra connector to the new drive in the following step, match the colored strip on the cable with pin 1 on the drive.

13. If you didn't install a controller card in [step 11](#), remove the tape from the wide cable connector and reattach the connector to the original drive. Then locate the extra connector on the cable and attach it to the new drive. Be sure that the wide cable is properly connected to the IDE connector on the system board.

If you installed a controller card in [step 11](#), attach the other end of the interface cable to the controller card rather than to the system board.

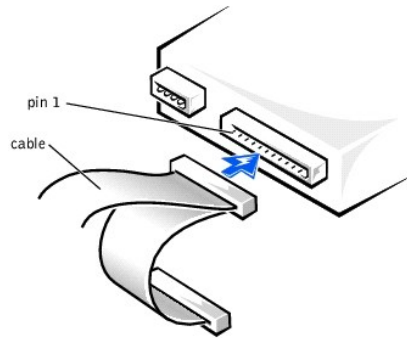

14. [Replace the front panel.](#)
 15. Make sure that no cable connections were loosened during the procedure. Arrange cables so that they will not interfere with replacing the power supply and computer cover.
 16. [Rotate the power supply](#) back into place.
 17. [Replace the computer cover.](#)
 18. Plug your computer and devices into their electrical outlets, and turn them on.
- 🔔 **NOTICE:** To connect a network cable, first plug the cable in to the network wall jack and then plug it in to the computer.
19. See the drive's documentation for instructions on installing any software required for drive operation.
-

Lower 3.5-Inch Floppy Drive

- ⚠ **CAUTION:** Before you begin any of the procedures in this section, follow the safety instructions in "[Safety Instructions.](#)"
- ⚠ **CAUTION:** To guard against electrical shock, always unplug your computer from the electrical outlet before opening the cover.
1. [Shut down the computer.](#)
 2. Turn off any attached devices and disconnect them from their electrical outlets.
- 🔔 **NOTICE:** To disconnect a network cable, first unplug the cable from your computer and then unplug it from the network wall jack.
3. Disconnect the computer power cable from the wall outlet, and then press the power button to ground the system board.
 4. [Remove the computer cover.](#)
 5. [Remove the front panel.](#)
 6. [Rotate the power supply](#) away from the system board.
 7. While holding the power supply, place the computer in the upright position.
 8. Disconnect the power and interface cables from the back of the floppy drive.
 9. Press the two drive-release rail tabs, and slide the drive out of the drive bay.

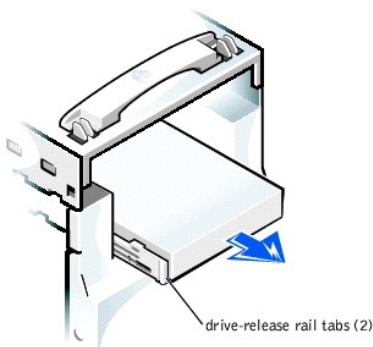

10. Remove the rails from each side of the existing drive, and install them on each side of the new drive.
 11. Slide the drive assembly into the drive bay.
 12. Connect the power and interface cables to the back of the floppy drive.
 13. [Replace the front panel.](#)
 14. Make sure that no cable connections were loosened during the procedure. Arrange cables so that they will not interfere with replacing the power supply and computer cover.
 15. [Rotate the power supply](#) back into place.
 16. [Replace the computer cover.](#)
 17. Plug your computer and devices into their electrical outlets, and turn them on.
- 🔑 **NOTICE:** To connect a network cable, first plug the cable in to the network wall jack and then plug it in to the computer.
18. See the drive's documentation for instructions on installing any software required for drive operation.
-

5.25-Inch Drive

- ⚠ **CAUTION:** Before you begin any of the procedures in this section, follow the safety instructions in "[Safety Instructions.](#)"
- ⚠ **CAUTION:** To guard against electrical shock, always unplug your computer from the electrical outlet before opening the cover.

1. [Shut down the computer.](#)
2. Turn off any attached devices and disconnect them from their electrical outlets.

🔑 **NOTICE:** To disconnect a network cable, first unplug the cable from your computer and then unplug it from the network wall jack.

3. Disconnect the computer power cable from the wall outlet, and then press the power button to ground the system board.
4. [Remove the computer cover.](#)
5. [Remove the front panel.](#)
6. [Rotate the power supply](#) away from the system board.
7. While holding the power supply, place the computer in the upright position.
8. Disconnect the power and interface cables from the back of the drive.
9. Press the two drive-release rail tabs, and slide the drive out of the drive bay.

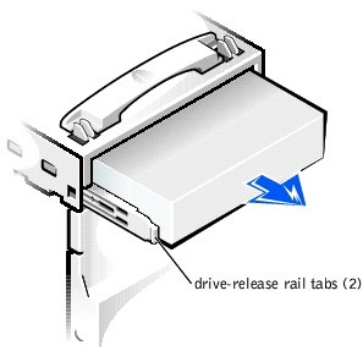

10. Before you install the new drive, install the drive-release rails on the sides of the replacement drive.
11. Slide the drive assembly into the drive bay.
12. Connect the power and interface cables to the back of the 5.25-inch drive.
13. [Replace the front panel.](#)
14. Make sure that no cable connections were loosened during the procedure. Arrange cables so that they will not interfere with replacing the power supply and computer cover.
15. [Rotate the power supply](#) back into place.
16. [Replace the computer cover.](#)
17. Plug your computer and devices into their electrical outlets, and turn them on.

➡ **NOTICE:** To connect a network cable, first plug the cable in to the network wall jack and then plug it in to the computer.

18. See the drive's documentation for instructions on installing any software required for drive operation.

Hard Drive

⚠ **CAUTION:** Before you begin any of the procedures in this section, follow the safety instructions in "[Safety Instructions](#)."

⚠ **CAUTION:** To guard against electrical shock, always unplug your computer from the electrical outlet before opening the cover.

1. [Shut down the computer](#).
2. Turn off any attached devices and disconnect them from their electrical outlets.

➡ **NOTICE:** To disconnect a network cable, first unplug the cable from your computer and then unplug it from the network wall jack.

3. Disconnect the computer power cable from the wall outlet, and then press the power button to ground the system board.
4. [Remove the computer cover](#).
5. [Remove the front panel](#).
6. [Rotate the power supply](#) away from the system board.
7. While holding the power supply, place the computer in the upright position.
8. Remove the two screws securing the hard drive to the front of the computer frame.

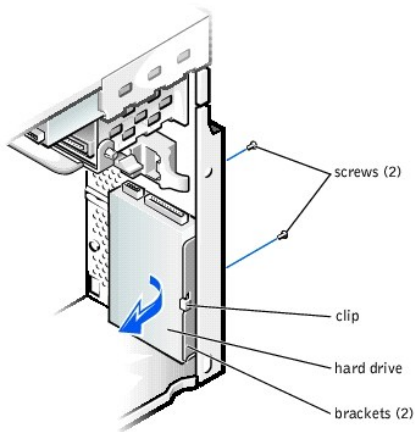

9. Release the clip that secures the drive to the computer frame, and rotate the drive out of the computer.
10. Disconnect the power and interface cables attached to the drive.
11. Remove the existing drive from the bay.

To reinstall the primary hard drive:

➡ **NOTICE:** When you reinstall the hard drive, make sure that the control panel wires are not caught underneath the hard drive.

1. Orient the new drive with its circuit board facing the front of the computer frame.
2. Press the drive between the two brackets until the drive is secured by the clip.
3. Secure the drive to the front of the computer frame with the two screws you removed in [step 8](#) of the previous procedure.
4. Connect the power and interface cables to the new drive.
5. [Replace the front panel](#).
6. Make sure that no cable connections were loosened during the procedure. Arrange cables so that they will not interfere with replacing the power supply and computer cover.
7. [Rotate the power supply](#) back into place.
8. [Replace the computer cover](#).
9. Plug your computer and devices into their electrical outlets, and turn them on.

🔑 **NOTICE:** To connect a network cable, first plug the cable in to the network wall jack and then plug it in to the computer.

10. See the drive's documentation for instructions on installing any software required for drive operation.

Power Supply and Fan Assembly

⚠️ **CAUTION:** Before you begin any of the procedures in this section, follow the safety instructions in "[Safety Instructions](#)."

⚠️ **CAUTION:** To guard against electrical shock, always unplug your computer from the electrical outlet before opening the cover.

1. [Shut down the computer](#).
2. Turn off any attached devices and disconnect them from their electrical outlets.

🔑 **NOTICE:** To disconnect a network cable, first unplug the cable from your computer and then unplug it from the network wall jack.

3. Disconnect the computer power cable from the wall outlet, and then press the power button to ground the system board.
4. [Remove the computer cover](#).
5. [Remove the front panel](#).
6. [Rotate the power supply](#) away from the system board.
7. Disconnect the power cables from the connectors on the system board.
8. Disconnect the power cables from all the drives.
9. Press the power-supply retaining clips and lift the power supply and fan assembly out of the computer.

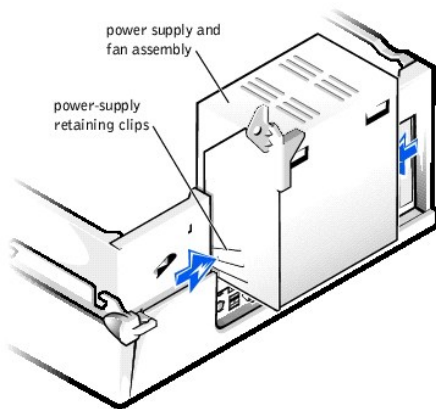

10. Insert the replacement power supply and fan assembly into the power-supply retaining clips.
11. Reconnect the power cables from the connectors on the system board.
12. Reconnect the power cables from all the drives.
13. [Rotate the power supply](#) back into place.
14. [Replace the front panel](#).
15. [Replace the computer cover](#).
16. Plug your computer and devices into their electrical outlets, and turn them on.

🔑 **NOTICE:** To connect a network cable, first plug the cable in to the network wall jack and then plug it in to the computer.

Control Panel

⚠️ **CAUTION:** Before you begin any of the procedures in this section, follow the safety instructions in "[Safety Instructions](#)."

⚠️ **CAUTION:** To guard against electrical shock, always unplug your computer from the electrical outlet before opening the cover.

1. [Shut down the computer](#).
2. Turn off any attached devices and disconnect them from their electrical outlets.

➡ **NOTICE:** To disconnect a network cable, first unplug the cable from your computer and then unplug it from the network wall jack.

3. Disconnect the computer power cable from the wall outlet, and then press the power button to ground the system board.
4. [Remove the computer cover.](#)
5. [Remove the front panel.](#)
6. Disconnect the control panel cable from the [FRONT PANEL connector](#) on the system board.
7. Press the mounting tabs to release the control panel and remove the control panel assembly.

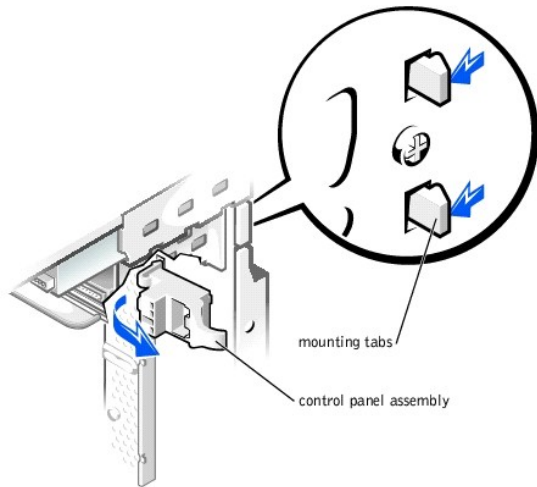

8. Install the replacement control panel by inserting its mounting tabs into the mounting-tab slots.
9. Reconnect the control panel cable to the [FRONT PANEL connector](#) on the system board.
10. Replace the front panel.
11. [Replace the computer cover.](#)
12. Plug your computer and devices into their electrical outlets, and turn them on.

➡ **NOTICE:** To connect a network cable, first plug the cable in to the network wall jack and then plug it in to the computer.

Adding or Removing Cards

Adding Cards

- ⚠ **CAUTION:** Before you begin any of the procedures in this section, follow the safety instructions in "[Safety Instructions.](#)"
- ⚠ **CAUTION:** To guard against electrical shock, always unplug your computer from the electrical outlet before opening the cover.

1. [Shut down the computer.](#)
2. Turn off any attached devices and disconnect them from their electrical outlets.

➡ **NOTICE:** To disconnect a network cable, first unplug the cable from your computer and then unplug it from the network wall jack.

3. Disconnect the computer power cable from the wall outlet, and then press the power button to ground the system board.
4. [Open the computer cover.](#)
5. [Rotate the power supply](#) away from the system board.
6. Unscrew and remove the filler bracket for the card slot you want to use.

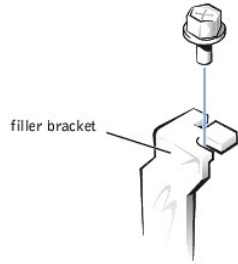

- Align the cutout on the bottom of the card with the crossbar in the system board connector. Gently rock the card into the connector until it is fully seated.

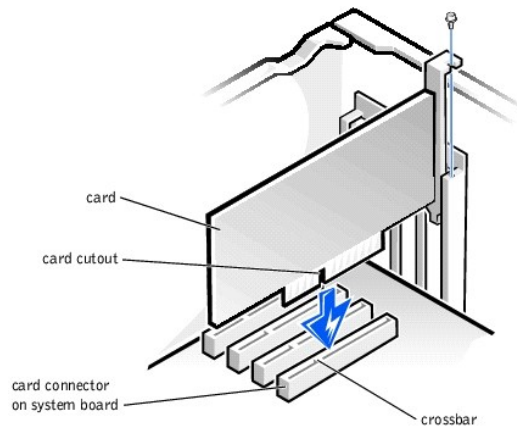

Make sure that the card is fully seated and that its bracket is within the card slot.

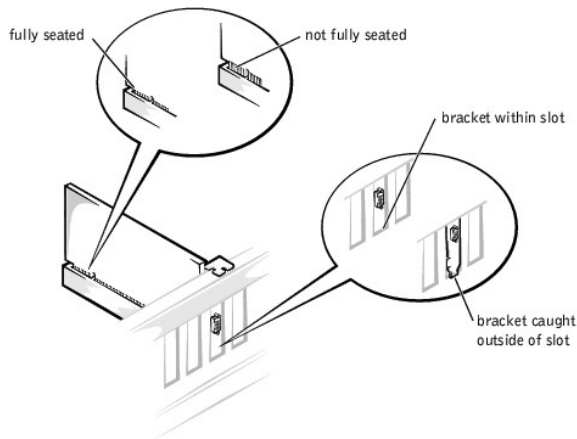



- Secure the bracket on the end of the card with the screw you removed in [step 6](#).
- Connect any cables required for the card as described in the card documentation.
- [Rotate the power supply](#) back into place.
- [Replace the computer cover](#).
- Plug your computer and devices into their electrical outlets, and turn them on.

➡ **NOTICE:** To connect a network cable, first plug the cable in to the network wall jack and then plug it in to the computer.

13. Install any drivers required for the card as described in the card documentation.

Removing Cards

 **CAUTION:** Before you begin any of the procedures in this section, follow the safety instructions in "[Safety Instructions](#)."

 **CAUTION:** To guard against electrical shock, always unplug your computer from the electrical outlet before opening the cover.

1. [Shut down the computer](#).
2. Turn off any attached devices and disconnect them from their electrical outlets.

 **NOTICE:** To disconnect a network cable, first unplug the cable from your computer and then unplug it from the network wall jack.

3. Disconnect the computer power cable from the wall outlet, and then press the power button to ground the system board.
4. [Remove the computer cover](#).
5. [Rotate the power supply](#) away from the system board.
6. Disconnect any cables connected to the card.
7. Remove the screw from the card bracket.
8. Grasp the card by its top corners, and lift it from the system board.
9. If you are removing the card permanently, reinstall a filler bracket.
10. [Rotate the power supply](#) back into place.
11. [Replace the computer cover](#).
12. Plug your computer and devices into their electrical outlets, and turn them on.

 **NOTICE:** To connect a network cable, first plug the cable in to the network wall jack and then plug it in to the computer.

Adding Memory

 **CAUTION:** Before you begin any of the procedures in this section, follow the safety instructions in "[Safety Instructions](#)."

 **CAUTION:** To guard against electrical shock, always unplug your computer from the electrical outlet before opening the cover.

You can increase your computer memory by installing memory modules on the system board. For information on the type of memory supported by your computer, look under "[Memory](#)" in "Technical Specifications."

 **HINT:** Memory purchased from Dell is covered under your computer warranty.

1. [Shut down the computer](#).
2. Turn off any attached devices and disconnect them from their electrical outlets.

 **NOTICE:** To disconnect a network cable, first unplug the cable from your computer and then unplug it from the network wall jack.

3. Disconnect the computer power cable from the wall outlet, and then press the power button to ground the system board.
4. [Remove the computer cover](#).
5. [Rotate the power supply](#) away from the system board.
6. If necessary, remove a memory module:
 - a. Press out the securing clip at each end of the memory connector.
 - b. Grasp the module and pull up.

If the module is difficult to remove, gently ease the module back and forth to remove it from the connector.

7. To insert a module, press out the securing clip at each end of the memory connector.

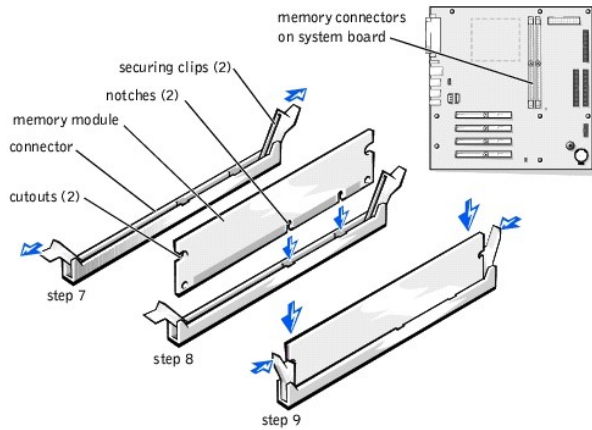

8. Align the notches on the bottom of the module with the crossbars in the connector.

➡ **NOTICE:** To avoid breaking the memory module, do not press near the middle of the module.

9. Insert the module straight down into the connector, making sure that it fits into the vertical guides at each end of the connector.

Press firmly on the ends of the module until it snaps into place.

If you insert the module correctly, the securing clips snap into the cutouts at each end of the module.

🔍 **HINT:** The system memory value reported by the operating system is 1 or 2 MB less than the memory installed because that memory is reserved for video functions.

10. [Rotate the power supply](#) back into place.

11. [Replace the computer cover](#).

➡ **NOTICE:** To connect a network cable, first plug the cable in to the network wall jack and then plug it in to the computer.

12. Plug your computer and devices into their electrical outlets, and turn them on.

Replacing the Battery

⚠ **CAUTION:** Before you begin any of the procedures in this section, follow the safety instructions in "[Safety Instructions](#)."

⚠ **CAUTION:** To guard against electrical shock, always unplug your computer from the electrical outlet before opening the cover.

A coin-cell battery maintains computer configuration, date, and time information. The battery can last several years.

If you have to repeatedly reset time and date information after turning on the computer, replace the battery.

⚠ **CAUTION:** A new battery can explode if it is incorrectly installed. Replace the 3-V CR2032 battery only with the same or equivalent type recommended by the manufacturer. Discard used batteries according to the manufacturer's instructions (see "Battery Disposal" in the *Owner's Manual*).

1. Record all the screens in the [system setup program](#) so that you can restore the correct settings in [step 12](#).

2. [Shut down the computer](#).

3. Turn off any attached devices and disconnect them from their electrical outlets.

➡ **NOTICE:** To disconnect a network cable, first unplug the cable from your computer and then unplug it from the network wall jack.

4. Disconnect the computer power cable from the wall outlet, and then press the power button to ground the system board.

5. [Remove the computer cover](#).

6. [Rotate the power supply](#) away from the system board.

➡ **NOTICE:** To avoid damage to the system board while you pry the battery loose, be sure to insert the plastic screwdriver between the battery and the socket (not the system board).

7. [Locate the battery socket BATTERY](#) on the system board and pry the battery out of its socket with your fingers or with a plastic screwdriver.

8. Insert the battery into the socket with the side labeled "+" facing up.

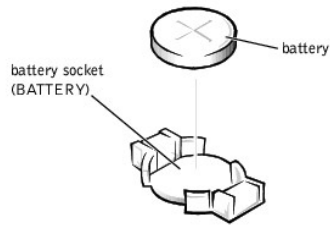

9. [Rotate the power supply](#) back into place.
10. [Replace the computer cover.](#)

➡ **NOTICE:** To connect a network cable, first plug the cable in to the network wall jack and then plug it in to the computer.

11. Plug your computer and devices into their electrical outlets, and turn them on.
12. Access the [system setup program](#) and restore the settings you recorded in [step 1](#).

Replacing the Microprocessor

⚠ **CAUTION:** Before you begin any of the procedures in this section, follow the safety instructions in "[Safety Instructions](#)."

⚠ **CAUTION:** To guard against electrical shock, always unplug your computer from the electrical outlet before opening the cover.

1. [Shut down the computer.](#)
2. Turn off any attached devices and disconnect them from their electrical outlets.

➡ **NOTICE:** To disconnect a network cable, first unplug the cable from your computer and then unplug it from the network wall jack.

3. Disconnect the computer power cable from the wall outlet, and then press the power button to ground the system board.
4. [Remove the computer cover.](#)
5. [Rotate the power supply](#) away from the system board.
6. [Locate the microprocessor socket](#) on the system board.
7. Release the metal clip that secures the heat sink and fan assembly to the microprocessor socket. Then remove the heat sink and fan assembly from the microprocessor chip.

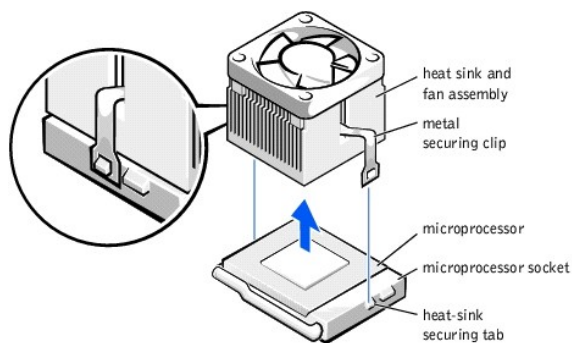

8. [Disconnect the fan](#) from the system board.
9. Your microprocessor socket is a zero insertion force (ZIF) socket with a lever handle that secures the chip in (or releases it from) the socket. To remove the chip, pull the microprocessor-socket release lever out to unlock it and then straight up until the chip is released.

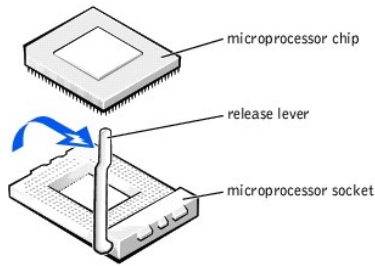

➡ **NOTICE:** Be careful not to bend any of the pins when you remove the microprocessor chip from its socket. Bending the pins can permanently damage the microprocessor chip.

10. Remove the chip from the socket. Leave the release lever extended so that the socket is ready for the new microprocessor.

➡ **NOTICE:** Ground yourself by touching an unpainted metal surface on the back of the computer.

➡ **NOTICE:** Be careful not to bend any of the pins when you unpack the microprocessor. Bending the pins can permanently damage the microprocessor.

11. Unpack the new microprocessor.

If any of the pins on the chip appear to be bent, obtain technical assistance.

12. Align the pin-1 corner of the microprocessor chip with the pin-1 corner of the microprocessor socket, as shown in the following illustration.

📌 **HINT:** You must identify the pin-1 corner to correctly position the chip.

The pin-1 corner of the microprocessor is the beveled corner. The pin-1 corner of the socket is marked with a white triangle on the system board.

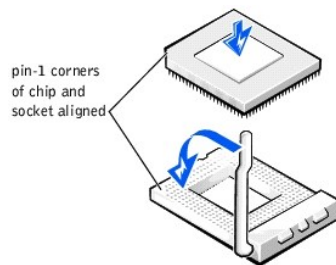

13. Install the microprocessor chip in the socket (as shown in the preceding illustration):

➡ **NOTICE:** You must position the microprocessor chip correctly in the socket to avoid permanent damage to the chip and the computer when you turn on the system.

- a. If the release lever on the microprocessor socket is not all the way out, move it to that position.
- b. With the pin-1 corners of the chip and socket aligned, align the pins on the chip with the holes in the socket.
- c. Set the chip lightly in the socket and make sure that all pins are headed into the correct holes. Because your system uses a ZIF microprocessor socket, you do not need to use force, which could bend the pins if the chip is misaligned. When the chip is positioned correctly, press it with minimal pressure to seat the microprocessor in the socket. Be careful not to bend the pins.
- d. When the chip is fully seated in the socket, pivot the microprocessor-socket release lever back toward the socket until it snaps into place, securing the chip.

➡ **NOTICE:** Ground yourself by touching an unpainted metal surface on the back of the computer.

14. Unpack the heat sink and fan assembly included in your upgrade kit.

15. Peel the release liner from the adhesive tape that is attached to the bottom of the heat sink and fan assembly.

➡ **NOTICE:** When you install the heat sink and fan assembly, make sure that the heat sink is flat against the surface of the processor while you are installing the clip. If the heat sink becomes tilted when you install the clip, excess heat can damage the processor.

16. Replace the heat sink and fan assembly:

- a. Place the heat sink and fan assembly on top of the microprocessor chip.
- b. Orient the securing clip and hook the shorter side of the clip over the tab on the top edge of the microprocessor socket.

- c. Press down on the top of the fan to snap the clip over the tab on the bottom edge of the microprocessor socket.
 - d. [Connect the fan](#) to the system board.
 17. [Rotate the power supply](#) back into place.
 18. [Replace the computer cover](#).
 19. Plug your computer and devices into their electrical outlets, and turn them on.
- ➡ **NOTICE:** To connect a network cable, first plug the cable in to the network wall jack and then plug it in to the computer.
20. As the computer boots, it detects the presence of the new microprocessor and automatically changes the system configuration information in the system setup program.
 21. [Enter the system setup program](#), and confirm that the **Processor Type** and **Processor Speed** options in the **Main** screen correctly identify the newly installed microprocessor.

Replacing the System Board

⚠ **CAUTION:** Before you begin any of the procedures in this section, follow the safety instructions in "[Safety Instructions](#)."

⚠ **CAUTION:** To guard against electrical shock, always unplug your computer from the electrical outlet before opening the cover.

1. If possible, [enter the system setup program](#) and either print the system setup screens by pressing the <Print Screen> key or write down the screen information before you turn off the computer because you will have to restore the configuration information after the system board is replaced.
2. [Shut down the computer](#).
3. Turn off any attached devices and disconnect them from their electrical outlets.

➡ **NOTICE:** To disconnect a network cable, first unplug the cable from your computer and then unplug it from the network wall jack.

4. Disconnect the computer power cable from the wall outlet, and then press the power button to ground the system board.
5. [Remove the computer cover](#).
6. [Remove the power supply](#).
7. Disconnect any cables connected to cards, and then [remove the cards](#).
8. Disconnect all internal cables from the system board.
9. [Remove the microprocessor](#).
10. [Remove the memory modules](#).
11. Push the system-board retaining clip until it disengages.

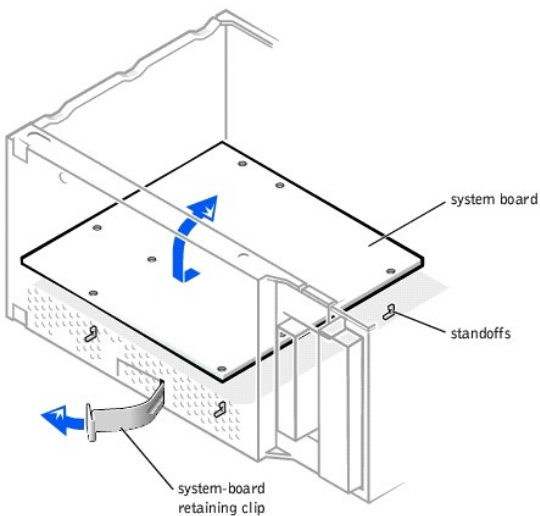

🔍 **HINT:** You may need to slide the board toward the front of the computer to clear the hooked standoffs before you can lift the board from the computer.

12. Slide the system board forward until it is no longer held by the standoffs that secure the system board to the computer frame.

- Carefully lift the system board out of the I/O gasket and remove the board from the computer. The I/O gasket is on the back of the computer where all of the input and output ports are located.
- Install the replacement board.

When you install the replacement system board, angle the back of the board downward and carefully align the connectors on the back edge of the board with the cutouts in the I/O gasket. When properly aligned, the board connectors slide into the I/O gasket as you lower the board into position in the computer and reseal it on the standoffs. Lock the board in place with the system-board retaining clip.

- Replace the [microprocessor](#), the [memory modules](#), and the [cards](#) that you removed from the old system board.
- Reconnect all internal cables to the system board.
- [Rotate the power supply](#) back into place.
- [Replace the computer cover](#).

 **NOTICE:** To connect a network cable, first plug the cable in to the network wall jack and then plug it in to the computer.

- Plug your computer and devices into their electrical outlets, and turn them on.
 - [Reenter the system setup program](#) and reset the configuration information.
-

Replacing the Computer Cover

- Rotate the power supply back into place.
- Check all cable connections, especially those that might have come loose during your work. Fold cables and unused connectors out of the way so that they do not catch on the computer cover or interfere with airflow inside the computer.
- Check to see that no tools or extra parts (including screws) are left inside the computer.
- Place the computer upright with the front facing you. Align the computer cover so its bottom hooks fit in the computer's curved hinge.
- Lift up the cover, making sure to keep the bottom hooks aligned with the curves in the computer.
- Gently squeeze the right and left sides of the computer together until the cover clicks into position.

 **NOTICE:** To connect a network cable, first plug the cable in to the network wall jack and then plug it in to the computer.

- Connect your computer and devices to their electrical outlets, and turn them on.
-

[Back to Contents Page](#)

[Back to Contents Page](#)

Solving Problems

Dell™ Dimension™ 2200

- [Accessing Help Files](#)
- [Power Problems](#)
- [Start-Up Error Messages](#)
- [Video and Monitor Problems](#)
- [Sound and Speaker Problems](#)
- [Printer Problems](#)
- [Scanner Problems](#)
- [Modem Problems](#)
- [Mouse Problems](#)
- [Keyboard Problems](#)
- [Drive Problems](#)
- [Network Problems](#)
- [Microsoft® Windows® Error Messages](#)
- [General Program Problems](#)
- [Internet Connection Problems](#)
- [E-Mail Problems](#)
- [Resolving Other Technical Problems](#)
- [Reinstalling Drivers](#)
- [Resolving Software and Hardware Incompatibilities](#)
- [Using System Restore](#)
- [Reinstalling Windows XP](#)
- [Reinstalling Windows 2000](#)

Accessing Help Files

<p>To access the <i>Tell Me How</i> help file</p> <p><i>Microsoft Windows XP</i></p> <ol style="list-style-type: none">1. Click the Start button, and then click Help and Support.2. Click User and system guides, and then click User's guides.3. Click Tell Me How. <p><i>Windows 2000</i></p> <p>Click the Start button, point to Programs, point to User's Guides, and then click Tell Me How.</p>
<p>To access help in Windows XP</p> <ol style="list-style-type: none">1. Click the Start button, and then click Help and Support.2. Type a word or phrase that describes your problem, and then click the arrow icon.3. Click the topic that describes your problem, and then click Display.4. Follow the instructions shown on the screen.
<p>To access help in Windows 2000</p> <ol style="list-style-type: none">1. Click the Start button, and then click Help.2. Click the Search tab.3. Type a word or phrase that describes your problem, and then click List Topics.4. Click the topic that describes your problem, and then click Display.5. Follow the instructions shown on the screen.

Power Problems

 **HINT:** See the [Tell Me How](#) help file for information on the standby mode.

<p>Check the power light— When the power light is lit or blinking, the computer has power. If the power light is blinking, the computer is in standby mode—press a key on the keyboard or move the mouse.</p>
<p>Test the electrical outlet— Ensure that the electrical outlet is working by testing it with another device, such as a lamp.</p>
<p>Check the power cable connection— Be sure that the power cable is firmly inserted into the electrical outlet and the computer.</p>
<p>Connect the computer directly to an electrical outlet— Bypass power protection devices, power strips, and the extension cable to verify that the computer turns on.</p>
<p>Swap the computer and monitor power cables— Swap the computer and monitor power cables to determine if the power cable is defective.</p>
<p>Check for interference— Electrical appliances on the same circuit or operating near the computer can cause interference. Other causes of interference: power extension cables, keyboard and mouse extension cables, too many devices on a power strip, or multiple power strips connected to the same electrical outlet.</p>
<p>Check the Power Properties— See the Tell Me How help file or search for the keyword <i>standby</i> in the Help and Support Center (<i>Help</i> in Windows 2000).</p>

Start-Up Error Messages

<p>Operating system not found— Call Dell for technical assistance. See "Contacting Dell" in the Dell™ <i>Owner's Manual</i> for the correct number to call.</p>
--

Insert bootable media— The operating system is trying to boot to a nonbootable floppy disk or CD. Insert a bootable floppy disk or CD.

Non-system disk error— There is a floppy disk in the floppy drive. Remove the floppy disk and restart the computer.

Video and Monitor Problems

If the screen is blank

 **HINT:** See the documentation that came with your monitor for fault indications and troubleshooting procedures specific to your monitor.

Check the video cable connection— Check for bent pins (most video cable connectors have missing pins, but not bent pins). Ensure that the video cable is connected as shown on the *START HERE* sheet for your computer.

Press the monitor power button— Be sure that you firmly pressed the monitor power button.

Check the power light— When the power light is lit or blinking, the monitor has power. If the power light is blinking, press a key on the keyboard or move the mouse.

Test the electrical outlet— Ensure that the electrical outlet is working by testing it with another device, such as a lamp.

Swap the computer and monitor power cables— Swap the computer and monitor power cables to determine if the power cable is defective.

Test the video extension cable (if used)— If you are using a video extension cable and removing the cable solves the problem, the cable is defective.

Test the monitor— If another monitor is available, connect it to the computer.

Check the back panel lights— If all four lights below the serial connector are not green, call Dell for technical assistance. See "Contacting Dell" in the *Dell Owner's Manual* for the correct number to call.

Check the Power Properties— See the [Tell Me How](#) help file or search for the keyword *standby* in the Help and Support Center (*Help in Windows 2000*).

If the screen is difficult to read

Adjust the contrast and brightness— See the documentation that came with your monitor for instructions on adjusting the contrast and brightness.

Move the subwoofer away from the monitor— If your speaker system includes a subwoofer, ensure that the subwoofer is at least 60 cm (2 ft) away from the monitor.

Move the monitor away from external power sources— Fans, fluorescent lights, halogen lamps, and other electrical devices can cause the screen image to appear "shaky." Turn off nearby devices to check for interference.

Rotate the monitor to face a different direction— Eliminate sunlight glare, which can cause poor picture quality.

Degauss (demagnetize) the monitor— See the documentation that came with your monitor.

Run the monitor self-test— See the documentation that came with your monitor.

Restore the recommended settings— Restore the original resolution and refresh rate settings. See the [Tell Me How](#) help file for instructions.

Check for additional adjustments— See the documentation that came with your monitor for any additional adjustments that your monitor may require.

Adjust the Windows display settings

Windows XP

1. Click the **Start** button, and then click **Control Panel**.
2. Click **Appearance and Themes**.
3. Click **Display**, and then click the **Settings** tab.
4. Try different settings for **Screen resolution** and **Color quality**.

Windows 2000

1. Click the **Start** button, point to **Settings**, and then click **Control Panel**.
2. Double-click the **Display** icon, and then click the **Settings** tab.
3. Try different settings for **Colors and Screen area**.

Check for interrupt request conflicts— See "[Resolving Software and Hardware Incompatibilities](#)."

Sound and Speaker Problems

 **HINT:** The volume control in some MP3 players overrides the Windows volume setting. If you have been listening to MP3 songs, make sure that you did not turn the player volume down or off.

Ensure that the subwoofer and the speakers are turned on— See the setup diagram supplied with the speakers.

Adjust the speaker controls— Adjust the volume, bass, or treble controls to eliminate distortion.

Verify the speaker cable connections— Ensure that the speakers are connected as shown on the *START HERE* sheet for your computer and the setup diagram supplied with the speakers.

Adjust the Windows volume control— In Windows XP, click the speaker icon in the lower-right corner of your screen. In Windows 2000, double-click the speaker icon in the lower-right corner of your screen. Be sure that the volume is turned up and that the sound is not muted.

Run the speaker diagnostics — Some speaker systems have self-contained diagnostics. See the speaker documentation for diagnostics instructions.
Eliminate possible interference — Turn off nearby fans, fluorescent lights, or halogen lamps to check for interference.
Test the electrical outlet — Ensure that the electrical outlet is working by testing it with another device, such as a lamp.
Reinstall the Sound (audio) driver — See " Reinstalling Drivers ."
Check for interrupt request conflicts — See " Resolving Software and Hardware Incompatibilities ."

Printer Problems

 **HINT:** If you need technical assistance for your printer, call the printer's manufacturer. Dell does not cover the printer's warranty.

If you cannot print to a parallel port printer

Verify the printer cable connections — Ensure that the printer cable is connected as described in "Connecting a Printer" in the <i>Dell Owner's Manual</i> .
Ensure that the printer is turned on — See the documentation supplied with the printer.
<p>Verify that the printer is recognized by Windows</p> <p><i>Windows XP</i></p> <ol style="list-style-type: none"> 1. Click the Start button. 2. Click Control Panel. 3. Click Printers and Other Hardware. 4. Click View installed printers or fax printers. <p>If the printer is listed, right-click the printer icon.</p> <ol style="list-style-type: none"> 5. Click Properties, and then select the Ports tab. Ensure that the Print to the following port(s): setting is LPT1 (Printer Port). <p><i>Windows 2000</i></p> <ol style="list-style-type: none"> 1. Click the Start button, point to Settings, and then click Printers. <p>If the printer is listed, right-click the printer icon.</p> <ol style="list-style-type: none"> 2. Click Properties, and then select the Ports tab. Ensure that the Print to the following port(s): setting is LPT1 (Printer Port).
Test the electrical outlet — Ensure that the electrical outlet is working by testing it with another device, such as a lamp.
Reinstall the printer driver — See "Installing the Printer Driver" in the <i>Dell Owner's Manual</i> .
Check for interrupt request conflicts — See " Resolving Software and Hardware Incompatibilities ."

If you cannot print to a USB printer

Verify the printer cable connections — Ensure that the printer cable is connected as described in "Connecting a Printer" in the <i>Dell Owner's Manual</i> .
Ensure that the printer is turned on — See the documentation supplied with the printer.
<p>Verify that the printer is recognized by Windows</p> <p><i>Windows XP</i></p> <ol style="list-style-type: none"> 1. Click the Start button. 2. Click Control Panel. 3. Click Printers and Other Hardware. 4. Click View installed printers or fax printers. <p>If the printer is listed, right-click the printer name.</p> <ol style="list-style-type: none"> 5. Click Properties, and then select the Ports tab. Ensure that the Print to the following port(s): setting is USB. <p><i>Windows 2000</i></p> <ol style="list-style-type: none"> 1. Click the Start button, point to Settings, and then click Printers. <p>If the printer is listed, right-click the printer icon.</p> <ol style="list-style-type: none"> 2. Click Properties, and then select the Ports tab. Ensure that the Print to the following port(s): setting is USB.
Test the electrical outlet — Ensure that the electrical outlet is working by testing it with another device, such as a lamp.
Reinstall the printer driver — See "Installing the Printer Driver" in the <i>Dell Owner's Manual</i> .
Check for interrupt request conflicts — See " Resolving Software and Hardware Incompatibilities ."

Scanner Problems

 **HINT:** If you need technical assistance for your scanner, call the scanner's manufacturer. Dell does not cover the scanner's warranty.

Check the power cable connection — Ensure that the scanner power cable is firmly connected to a working electrical power source and that the scanner is turned on.
Check the scanner cable connection — Ensure that the scanner cable is firmly connected to the computer and to the scanner.
Unlock the scanner — Ensure that your scanner is unlocked if it has a locking tab or button.
Reinstall the scanner driver — Reinstall the scanner driver. See the scanner documentation for instructions.
Check for interrupt request conflicts — See " Resolving Software and Hardware Incompatibilities ."

Modem Problems

 **HINT:** Connect the modem to an analog telephone jack only. The modem does not operate while it is connected to a digital telephone network.

Check the connection — Verify that the telephone line is connected to the green jack on the modem. (The green line-in jack has either a LINE IN label or a connector-shaped icon next to it.) Make sure that you hear a click when you insert the telephone line connector.
Check the telephone jack — Disconnect the telephone line from the modem and connect it to a telephone. Listen for a dial tone.
Connect the modem directly to the telephone wall jack — If you have other telephone devices sharing the line, such as an answering machine, fax machine, surge protector, or line splitter, then bypass them and connect the modem directly to the telephone wall jack with the telephone line.
Check the telephone line — Try using a different telephone line. If you are using a line that is 3 m (10 ft) or more in length, try a shorter one.
Verify that the modem is communicating with Windows <i>Windows XP</i> <ol style="list-style-type: none">1. Click the Start button.2. Click Control Panel.3. Click Network and Internet Connections.4. Click Internet Options.5. Click Network Diagnostics and perform the connectivity test. <i>Windows 2000</i> <ol style="list-style-type: none">1. Click the Start button, point to Settings, and click Control Panel.2. In the Control Panel, double-click Phone and Modem Options. <p>If there are multiple entries for the same modem or modems listed that are not installed, delete the entries and restart the computer.</p> <ol style="list-style-type: none">3. Click the Modems tab.4. Click the COM port for your modem.5. Click Properties.6. Click the Diagnostics tab to verify that the modem is communicating with Windows. <p>If all commands receive responses, the modem is operating properly.</p>
Be sure that you have subscribed to an Internet service provider — Contact an Internet service provider to subscribe.
Check for interrupt request conflicts — See " Resolving Software and Hardware Incompatibilities ."

Mouse Problems

If you connected the mouse before turning on the computer, reconnect the mouse cable <ol style="list-style-type: none">1. Press <Ctrl><Esc> to display the Start menu.2. In Windows XP, type u, and then type u again. In Windows 2000, use the keyboard arrow keys to highlight Shut Down, and then press <Enter>.3. After the computer turns off, reconnect the mouse cable as shown on the <i>START HERE</i> sheet for your computer.4. Start the computer.
If you connected the mouse after turning on the computer, remove the power cable, and then reconnect the mouse cable — If the mouse is connected after the power is turned on, the mouse will appear to be nonfunctional. To make the mouse function properly: <ol style="list-style-type: none">1. While your computer is on, remove the power cable from the back of the computer.2. Connect the mouse to the computer.3. Reconnect the power cable.4. Turn on your computer. <p>Pressing the power button does not clear the computer's settings and does not restore mouse functionality.</p>
Check the mouse settings

Windows XP

1. Click the **Start** button, click **Control Panel**, and then click **Printers and Other Hardware**.
2. Click **Mouse**.
3. Try adjusting the settings.

Windows 2000

1. Click the **Start** button, point to **Settings**, and then click **Control Panel**.
2. Double-click the **Mouse** icon.
3. Try adjusting the settings.

Check for interrupt request conflicts— See "[Resolving Software and Hardware Incompatibilities](#)."

Keyboard Problems

Reconnect the keyboard cable— [Shut down the computer](#), reconnect the keyboard cable as shown on the *START HERE* sheet for your computer, and then restart the computer.

Check for interrupt request conflicts— See "[Resolving Software and Hardware Incompatibilities](#)."

Drive Problems

If you cannot save a file to a floppy disk

 **HINT:** See "[Accessing Help Files](#)" for information on saving files to a floppy disk.

Ensure that Windows recognizes the drive— In Windows XP, click the **Start** button, and then click **My Computer**. In Windows 2000, double-click the **My Computer** icon on the Windows desktop. If the floppy drive is not listed, perform a full scan with your antivirus software to check for and remove viruses. Viruses can sometimes prevent Windows from recognizing the drive.

Test the drive with another floppy disk— Insert another floppy disk to eliminate the possibility that the original floppy disk is defective.

Cannot save files to a floppy disk— Ensure that the floppy disk is not full or write-protected (locked). See the following illustration.

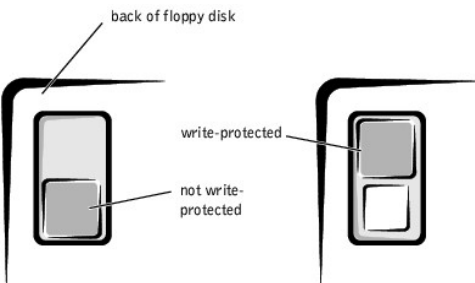

If you cannot play a music CD or install a program from a CD

 **HINT:** High-speed CD drive vibration is normal and may cause noise. This does not indicate a defect in the drive or the CD.

Ensure that Windows recognizes the drive— In Windows XP, click the **Start** button, and then click **My Computer**. In Windows 2000, double-click the **My Computer** icon on the Windows desktop. If the CD drive is not listed, perform a full scan with your antivirus software to check for and remove viruses. Viruses can sometimes prevent Windows from recognizing the drive.

Test the drive with another CD— Insert another CD to eliminate the possibility that the original CD is defective.

Clean the disc— See the [Tell Me How](#) help file for instructions.

Adjust the Windows volume control— In Windows XP, click the speaker icon in the lower-right corner of your screen. In Windows 2000, double-click the speaker icon in the lower-right corner of your screen. Be sure that the volume is turned up and that the sound is not muted.

Check the speakers and subwoofer— See "[Sound and Speaker Problems](#)."

If you cannot play a DVD movie

 **HINT:** Because of different worldwide file types, not all DVD titles work in all DVD drives.

Adjust the Windows volume control— In Windows XP, click the speaker icon in the lower-right corner of your screen. In Windows 2000, double-click the speaker icon in the lower-right corner of your screen. Be sure that the volume is turned up and that the sound is not muted.

Test the drive with another DVD— Insert another DVD to eliminate the possibility that the original DVD is defective.

Clean the disc— See the [Tell Me How](#) help file for instructions.

If the CD-RW drive stops writing

 **HINT:** If you disable standby mode to write to a CD-RW drive, remember to reenable standby mode when you finish writing to the CD.

Turn off Standby in Windows before writing to a CD-RW disc— See the [Tell Me How](#) help file or search for the keyword *standby* in the Help and Support Center (*Help* in Windows 2000).

Change the write speed to a slower rate— The CD-RW drive must receive a steady stream of data when writing. If the stream is interrupted, an error occurs. Closing all programs before writing to the CD-RW may also alleviate the problem.

If you have a hard drive problem

Run Check Disk

1. In Windows XP, click the **Start** button, and then click **My Computer**. In Windows 2000, double-click the **My Computer** icon on the Windows desktop.
2. Right-click the drive letter (local disk) that you want to scan for errors, and then click **Properties**.
3. Click the **Tools** tab.
4. Under **Error-checking**, click **Check Now**.
5. Click **Start**.

Check for interrupt request conflicts— See "[Resolving Software and Hardware Incompatibilities](#)."

Network Problems

Check the network cable connector— Ensure that the network cable connector is firmly connected to the connector on the computer and the network wall jack as shown on the *START HERE* sheet for your computer.

Check the network lights on the back of the computer— A green light indicates a 10 Mbps network connection, and an orange light indicates a 100 Mbps network connection. The light blinks amber when there is any network traffic. If the light is dark, try replacing the network cable.

Restart the computer— Try to log on to the network again.

Contact your network administrator— Verify that your network settings are correct and that the network is functioning.

Check for interrupt request conflicts— See "[Resolving Software and Hardware Incompatibilities](#)."

Microsoft® Windows® Error Messages

x:\ is not accessible. The device is not ready— Insert a disk into the drive and try again.

A filename cannot contain any of the following characters: \ / : * ? " < > |— Do not use these characters in filenames.

Not enough memory or resources. Close some programs and try again— You have too many programs open. Close all windows and open the program that you want to use. In some cases, you might have to restart your computer to restore computer resources. If so, try running the program that you want to use first.

The file being copied is too large for the destination drive— The file that you are trying to copy is too large to fit on the disk. Try copying the file to a blank disk or use a larger capacity disk.

A required .DLL file was not found— The program that you are trying to open is missing an essential file. To remove and then reinstall the program:

Windows XP

1. Click the **Start** button.
2. Click **Control Panel**.
3. Click **Add or Remove Programs**.
4. Select the program you want to remove.
5. Click the **Change or Remove Program** icon.
6. See the program documentation for installation instructions.

Windows 2000

1. Click the **Start** button, point to **Settings**, and then click **Control Panel**.
2. Double-click the **Add/Remove Programs** icon.
3. Select the program that you want to remove.
4. Click **Change/Remove** and follow the prompts on the screen.
5. See the program documentation for installation instructions.

General Program Problems

A program crashes

See the software documentation— Many software manufacturers maintain websites with information that may help you to solve the problem.

A program stops responding

End the program

1. Simultaneously press <Ctrl><Shift><Esc>.
2. Click **Task Manager**, click the **Applications** tab, and then select the program that is no longer responding.
3. Click **End Task**.

A program error causes the system to lock up

 **HINT:** Check Disk may run when you restart the computer. Follow the instructions on the screen.

Turn the computer off— If your computer locks up and you are unable to get a response by pressing a key on your keyboard or moving your mouse, press the power button for at least 8 to 10 seconds until the computer turns off. Then press the power button again to turn on the computer. You might lose data if you are unable to perform a Microsoft Windows shutdown.

A solid blue screen appears

 **HINT:** Check Disk may run when you restart the computer. Follow the instructions on the screen.

Turn the computer off— If your computer locks up and you are unable to get a response by pressing a key on your keyboard or moving your mouse, press the power button for at least 8 to 10 seconds until the computer turns off. Then press the power button again to turn on the computer. The solid blue screen appears because you were not able to perform a proper Windows shutdown. You might lose data if you are unable to perform a Microsoft Windows shutdown.

A program is designed for an earlier Windows operating system

Run the Program Compatibility Wizard Windows XP provides a Program Compatibility Wizard that configures a program to run in an environment more similar to older Windows operating system environments.

1. Click the **Start** button, point to **All Programs**—> **Accessories**, and then click **Program Compatibility Wizard**.
2. On the welcome screen, click **Next**.
3. Follow the instructions on the screen.

Internet Connection Problems

If you have a problem with your Internet connection

Review "[Modem Problems](#)."

Turn off call waiting (catch-phone)— See your telephone directory for instructions on deactivating this feature. Then adjust the dial-up networking connection properties.

Windows XP

1. Click the **Start** button, and then click **Control Panel**.
2. Click **Printers and Other Hardware**, and then click **Phone and Modem Options**.
3. Click to highlight your connection type in the displayed list.
4. Click the **Dialing Rules** tab, and then click **Edit**.
5. Click to place a checkmark in the **To Disable Call Waiting** box.
6. Select the disable code from the drop-down menu (for example, *70).
7. Click **Apply**, and then click **OK**.

Windows 2000

1. Click the **Start** button, point to **Settings**, and then click **Control Panel**.
2. Double-click the **Phone and Modems Options** icon.
3. In the **Locations** window, select the location for which you want to disable call waiting, and then click **Edit**.

4. Ensure that **To disable call waiting, dial:** is checked and then select the proper code according to the information in your telephone directory.
5. Click **Apply** and then click **OK**.
6. Close the **Phone and Modems Options** window.
7. Close the Control Panel.

Be sure that you have subscribed to an Internet service provider— Contact an Internet service provider to subscribe.

E-Mail Problems

Ensure that you are connected to the Internet— With the Outlook Express e-mail program open, click **File**. If **Work Offline** has a check next to it, click the check to remove it and connect to the Internet.

Resolving Other Technical Problems

Go to the Dell support website— Go to Dell | Support website for help with general usage, installation, and troubleshooting questions.

E-mail Dell— Go to Dell | Support website and then click **E-Mail Dell** in the **Communicate** list. Send an e-mail message to Dell about your problem: you can expect to receive an e-mail message from Dell within hours.

Call Dell— If you cannot solve your problem using the Dell | Support website or e-mail service, call Dell for technical assistance. See "Contacting Dell" in the *Dell Owner's Manual* for the correct number to call.

Reinstalling Drivers

 **NOTICE:** The Dell | Support website and the *Dell Dimension ResourceCD* provide approved drivers for Dell computers. If you install drivers obtained from other sources, your computer might not work correctly.

A driver is a software program that allows a hardware device controller to function properly and to communicate with the computer. Sometimes you can fix a device problem by reinstalling its driver:

1. From the Windows desktop, insert the *Dell Dimension ResourceCD* into the CD or DVD drive.

If this is your first time to use the *ResourceCD*, go to [step 2](#). If not, go to [step 5](#).
2. When the ResourceCD Installation program starts, follow the prompts on the screen.
3. When the **InstallShield Wizard Complete** window appears, remove the *ResourceCD* and click **Finish** to restart the computer.
4. When you see the Windows desktop, reinsert the *ResourceCD* into the CD or DVD drive.
5. At the **Welcome Dell System Owner** screen, click **Next**.

 **HINT:** The *ResourceCD* displays drivers only for hardware that Dell installed at the time of purchase. If you installed any additional hardware, those drivers may not be displayed by the *ResourceCD*. If those drivers are not displayed, exit the *ResourceCD* program and refer to the documentation and drivers that came with that product.

A message appears that says the *ResourceCD* is detecting hardware in your computer.

The drivers that are used by your computer are automatically displayed in the **My Drivers—The ResourceCD has identified these components in your system** window.

6. Click the driver that you want to reinstall and follow the instructions on the screen.

If a particular driver is not listed, then that driver is not required by your operating system.

To view other contents on the *ResourceCD*:

1. Verify that your computer is selected in the **System Model** list.
2. Verify that your operating system is selected in the **Operating System** list.
3. Select the type of device in the **Device Type** list.

 **NOTICE:** The *ResourceCD* contains drivers for devices that are not part of your computer. Only reinstall the specific drivers for hardware included in your computer. Otherwise, your computer might not work correctly.

4. Select a topic in the **Topic** list.

If you select **Drivers** in the **Topic** list and a particular driver is not listed, then that driver is not required by your operating system.

Using the Windows XP Device Driver Rollback

If you install a new device driver that causes system instability and you need to replace a device driver with a previously installed version, the Windows XP Device Driver Rollback can replace the device driver. If you cannot reinstall your previous driver with the Driver Rollback process, then use [System Restore](#) to

attempt to return your operating system to its previous operating state before the new device driver installation:

1. Click the **Start** button, and then right-click **My Computer**.
 2. Click **Properties**.
 3. Click the **Hardware** tab, and then click **Device Manager**.
 4. In the **Device Manager** window, right-click the device for which the new driver was installed, and then click **Properties**.
 5. Click the **Drivers** tab.
 6. Click **Roll Back Driver**.
-

Resolving Software and Hardware Incompatibilities

[Windows XP](#) and [Windows 2000](#) IRQ conflicts occur if a device either is not detected during the operating system setup or is detected but incorrectly configured.

Windows XP

To check for conflicts on a computer running Windows XP:

1. Click the **Start** button, and then click **Control Panel**.
2. Click **Performance and Maintenance**, and then click **System**.
3. Click the **Hardware** tab, and then click **Device Manager**.
4. In the **Device Manager** list, check for conflicts with the other devices.

Conflicts are indicated by a yellow exclamation point (!) beside the conflicting device or a red x if the device has been disabled.

5. Double-click any conflicting device listed to bring up the **Properties** window so you can determine what needs to be reconfigured or removed from the **Device Manager**.

Resolve these conflicts before checking specific devices.

6. Double-click the malfunctioning device type in the **Device Manager** list.
7. Double-click the icon for the specific device in the expanded list.

The **Properties** window appears.

8. Resolve any IRQ conflicts.

If there is an IRQ conflict, the **Device** status area in the **Properties** window reports what cards or devices are sharing the device's IRQ.

You can also use the Windows XP Hardware Troubleshooter. To use the troubleshooter, click the **Start** button and click **Help and Support**. Type **hardware troubleshooter** in the **Search** field, and then click the arrow to start the search. Click **Hardware Troubleshooter** in the **Search Results** list. In the **Hardware Troubleshooter** list, click **I need to resolve a hardware conflict on my computer**, and then click **Next**.

Windows 2000

To check for conflicts on a computer running Windows 2000:

1. Click the **Start** button, point to **Settings**, and click **Control Panel**.
2. In the **Control Panel**, double-click **System**.
3. Click the **Hardware** tab.
4. Click **Device Manager**.
5. Click **View**, and then click **Resources by connection**.
6. Double-click **Interrupt request (IRQ)** to view the IRQ assignments.

Conflicts are indicated by a yellow exclamation point (!) beside the conflicting device or a red x if the device has been disabled.

7. Double-click any conflicting device listed to bring up the **Properties** window so you can determine what needs to be reconfigured or removed from the **Device Manager**. Resolve these conflicts before checking specific devices.
8. Double-click the malfunctioning device type in the **Device Manager** list.
9. Double-click the icon for the specific device in the expanded list.

The **Properties** window appears.

If there is an IRQ conflict, the **Device status** area in the **Properties** window reports what cards or devices are sharing the device's IRQ.

10. Resolve the IRQ conflicts.

You can also use the Windows 2000 Hardware Troubleshooter. To use the troubleshooter, click the **Start** button and click **Help**. Click **Troubleshooting and Maintenance** on the **Contents** tab, click **Windows 2000 troubleshooters**, and then click **Hardware**. In the **Hardware Troubleshooter** list, click **I need to resolve a hardware conflict on my computer**, and then click **Next**.

Using System Restore

Windows XP provides a System Restore feature that allows you to return your computer to an earlier operating state if changes to the computer's hardware or software (including new hardware or program installations), or other system settings, have left the computer in an undesirable operating state. You can also undo the last System Restore.

System Restore automatically creates system checkpoints. You can also manually create your own checkpoints by creating Restore Points. To limit the amount of hard disk space used, older restore points will be automatically purged.

If your computer experiences an operating system problem, you can use System Restore from Safe Mode or Normal Mode to return your computer to an earlier operating state.

System Restore does not cause you to lose personal files stored in the **My Documents** folder, data files, or e-mail messages after restoring the computer to an earlier time. If you restore the computer to a point before you installed a program, the program's data files won't be lost, but you will have to reinstall the actual program again.

 **NOTICE:** It is important to make regular backups of your data files. System Restore does not monitor changes to or recover your data files. If the original data on the hard disk is accidentally erased or overwritten, or becomes inaccessible because of a hard disk malfunction, you will need your backup files to recover the lost or damaged data.

System Restore is enabled on your new computer. However, if you reinstall Windows XP with less than 200 MB of free hard-disk space available, System Restore is automatically disabled. To see if System Restore is enabled:

1. Click the **Start** button, and then click **Control Panel**.
2. Click **Performance and Maintenance**.
3. Click **System**.
4. Click the **System Restore** tab.
5. Make sure that **Turn off System Restore** is unchecked.

Before proceeding with any System Restore function, Dell recommends that you thoroughly read Microsoft's information about using System Restore. To access this information:

1. Click the **Start** button, point to **All Programs**—> **Accessories**—> **System Tools**, and then click **System Restore**.
2. Click **Help** in the upper-right corner of the **Welcome to System Restore** screen.

Creating a Restore Point

Using the XP System Restore Wizard

In Windows XP you can manually create restore points or you can use the System Restore Wizard to create the restore points for you. To use the System Restore Wizard, click the **Start** button, click **Help and Support**, click **System Restore**, and then follow the instructions on the screen. You can also create and name a restore point if you are logged on as the computer administrator or a user with administrator rights.

Manually Creating the Restore Points

1. Click the **Start** button, point to **All Programs**—> **Accessories**—> **System Tools**, and then click **System Restore**.
2. Click **Create a restore point**.
3. Click **Next**.
4. Type a name for your new restore point in the **Restore point description** field.

The present date and time are automatically added to your restore point.

5. Click **Create**.
6. Click **OK**.

Restoring the Computer to an Earlier Operating State

If problems occur after installing a device driver, first try using [Device Driver Rollback](#). If that is unsuccessful, then use System Restore.

 **NOTICE:** Before restoring the computer to an earlier time, save and close all open files and close all open programs. Do not alter, open, or delete any files or programs until the system restoration is complete.

1. Click the **Start** button, point to **All Programs**—> **Accessories**—> **System Tools**, and then click **System Restore**.
2. Be sure that **Restore my computer to an earlier time** is selected, and then click **Next**.
3. Click a calendar date to which you want to restore your computer.

The **Select a Restore Point** screen provides a calendar that allows you to see and select restore points. All calendar dates with available restore points appear in bold.

4. Select a restore point, and then click **Next**.

If a calendar date has only one restore point, then that restore point is automatically selected. If two or more restore points are available, click the restore point that you want to use.

➡ **NOTICE:** Save and close all open files and close all open programs. Do not alter, open, or delete any files or programs until the system restoration is complete.

5. Click **Next**.

The **Restoration Complete** screen appears after System Restore completes collecting data, and then the computer automatically restarts.

After the computer restarts, click **OK**.

To change the restore point, you can either repeat the steps using a different restore point, or you can undo the restoration.

Undoing the Last System Restore

➡ **NOTICE:** Before undoing the last system restore, save and close all open files and close all open programs. Do not alter, open, or delete any files or programs until the system restoration is complete.

1. Click the **Start** button, point to **All Programs**—> **Accessories**—> **System Tools**, and then click **System Restore**.
2. Select **Undo my last restoration** and click **Next**.

➡ **NOTICE:** Save and close all open files and close all open programs. Do not alter, open, or delete any files or programs until the system restoration is complete.

3. Click **Next**.

The **System Restore** screen appears, and then the computer automatically restarts.

4. After the computer restarts, click **OK**.

Reinstalling Windows XP

Before reinstalling the Windows XP operating system to correct a problem, try correcting the problem by performing a Windows XP [System Restore](#).

➡ **NOTICE:** The *Operating System* CD provides options for reinstalling your Windows XP operating system. The options can potentially overwrite files installed by Dell and possibly affect programs installed on your hard drive. Therefore, Dell does not recommend that you reinstall your operating system unless instructed to do so by a Dell technical support representative.

➡ **NOTICE:** To prevent conflicts with Windows XP, you must disable any virus protection software installed on your computer before you reinstall Windows XP.

1. Insert the *Operating System* CD into the CD or DVD drive.

Close any program or utility that may start to run after you insert the CD into the drive.

🔍 **HINT:** The CD that you need to place in your CD or DVD drive is titled *Operating System*.

2. [Turn off the computer](#), and then turn the computer on again.
3. **When the blue DELL™ logo appears, press <F12> immediately.**

If you wait too long and the operating system logo appears, continue to wait until you see the Microsoft Windows desktop. Then shut down the computer and try again.

4. Use the arrow keys to select the CD-ROM option, and then press <Enter>.
5. When the **Windows XP Setup** screen appears, press <Enter> to select **To set up Windows now**.
6. Read the information in the **License Agreement** window, and then press <F8> on your keyboard to agree with the license information.
7. If your computer already has Windows XP installed and you want to recover your current Windows XP data, type **r** to select the repair option, and then go to step [15](#).

If you want to install a new copy of Windows XP, press <Esc> to select the fresh copy option, and then press <Enter> on the next screen to select the highlighted partition (recommended). Then follow the instructions on the screen.

The **Windows XP Setup** screen appears and Windows XP begins to copy files and install the devices. The computer automatically restarts multiple times before it requires additional input.



8. When the **Welcome to Microsoft** screen appears, click the green arrow icon at the bottom of the screen to continue. Follow the on-screen directions to finish.
9. When the **Regional Settings** screen appears, select the settings for your locale, and then click **Next**.
10. Enter your name and organization in the **Personalize Your Software** screen, and then click **Next**.
11. If you are reinstalling Windows XP Home Edition, enter a name for your computer when the **Computer Name** window appears, and then click **Next**.

If you are reinstalling Windows XP Professional, enter a name for your computer and a password when the **Computer Name and Administrator Password** window appears, and then click **Next**.

12. If you have a modem installed and the **Modem Dialing Information** screen appears, enter the requested information, and then click **Next**.
13. Enter the date, time, and time zone in the **Date and Time Settings** window, and then click **Next**.

14. If you have a network card in your computer, select the appropriate network settings. If you do not have a network card, this option does not appear.
Windows XP begins to install its components and configure the computer. The computer automatically restarts.
 15. When the **Welcome to Microsoft** screen appears, click the green arrow icon at the bottom of the screen to continue. Follow the on-screen directions to finish.
 16. Remove the CD from the drive.
 17. Reinstall the appropriate drivers. See "[Reinstalling Drivers](#)."
 18. Reinstall your virus protection software.
-

Reinstalling Windows 2000

-  **NOTICE:** The *Operating System* CD provides options for reinstalling your Windows 2000 operating system. The options can potentially overwrite files installed by Dell and possibly affect programs installed on your hard drive. Therefore, Dell does not recommend that you reinstall your operating system unless instructed to do so by a Dell technical support representative.
-  **NOTICE:** To prevent conflicts with Windows 2000, you must disable any virus protection software installed on your computer before you reinstall Windows 2000.

1. Insert the *Operating System CD* into the CD or DVD drive.

Close any program or utility that may start to run after you insert the CD into the drive.

-  **HINT:** The CD that you need to place in your CD or DVD drive is titled *Operating System*.

2. [Turn off the computer](#), and then turn the computer on again.
3. When the blue DELL logo appears, press <F12> immediately.

If you wait too long and the operating system logo appears, continue to wait until you see the Microsoft Windows desktop. Then shut down the computer and try again.

4. Use the arrow keys to select the CD-ROM option, and then press <Enter>.
5. When the **Windows 2000 Setup** screen appears, ensure that the **To setup Win2000 now, press ENTER** option is highlighted. Then press <Enter>.
6. Read the information in the **License Agreement** screen, and then press <F8> to continue.
7. When the **Windows 2000 Professional Setup** screen appears, use the arrow keys to select the Windows 2000 partition option that you want. To continue, press the key specified in the partition option that you chose.
8. When the **Windows 2000 Professional Setup** screen reappears, use the arrow keys to select the type of filing system that you want Windows 2000 to use, and then press <Enter>.
9. Press <Enter> again to restart your computer.
10. Click **Next** when the **Welcome to the Windows 2000 Setup Wizard** screen appears.
11. When the **Regional Settings** screen appears, select the settings for your locale, and then click **Next**.
12. Enter your name and organization in the **Personalize Your Software** screen, and then click **Next**.
13. Type the Windows product key in the fields provided, and then click **Next**.

The product key is the bar code number found on the Microsoft Windows label, which is located behind the front-panel connector door as shown on the *START HERE* sheet for your computer.

14. When the **Computer Name and Administrator Password** screen appears, enter a name for your computer and a password, if desired. Then click **Next**.
15. Enter the date and time in the **Date and Time Settings** screen, and then click **Next**.

Windows 2000 now begins to install its components and configure the computer.

16. When the **Completing the Windows 2000 Setup Wizard** screen appears, remove the CD from the drive, and then click **Finish**.

The computer automatically restarts.

[Back to Contents Page](#)

[Back to Contents Page](#)

Technical Specifications

Dell™ Dimension™ 2200

- [Microprocessor](#)
- [System Information](#)
- [Expansion Bus](#)
- [Memory](#)
- [Drives](#)
- [Ports and Connectors](#)
- [Video](#)
- [Audio](#)
- [Controls and Lights](#)
- [Power](#)
- [Physical](#)
- [Environmental](#)

Microprocessor	
Microprocessor type	Intel® Celeron® microprocessor that runs at 1.20, 1.30, or 1.40 GHz internally and 100 MHz externally <i>NOTE: Microprocessor offerings vary by country.</i>
L1 cache	32 KB (16-KB data cache; 16-KB instruction cache)
L2 cache	256-KB SRAM that resides in the processor's core. The L2 cache runs at the processor's internal clock speed.

System Information	
System chip set	Intel 810E
DMA channels	two
Interrupt levels	24 APIC mode
System BIOS chip	4 Mb (512 KB)
System clock speed	100 MHz

Expansion Bus	
Bus types	PCI (version 2.2)
Bus speed	PCI: 33 MHz
PCI connectors	supports four three-quarter-length cards
PCI connector size	120 pins
PCI connector data width (maximum)	32 bits

Memory	
Architecture	non-ECC SDRAM modules
Memory connectors	two: gold contacts
Memory capacities	128, 256, and 512 MB (non-ECC)
Minimum memory	128 MB (non-ECC)
Maximum memory	512 MB (non-ECC)
Frequency	100 MHz
Voltage	3.3 V
Data bus width	64 bits

Drives	
Externally accessible	one 5.25-inch bay two 3.5-inch bays
Internally accessible	one bay for 1-inch-high IDE hard drive
Available devices	ATA-66 Ultra DMA hard drive, CD drive, DVD drive, and CD-RW drive

Ports and Connectors	
Externally accessible:	
Serial	9-pin connector; 16550C-compatible
Parallel	25-hole connector (bidirectional)
Video	15-hole connector
Keyboard	6-pin mini-DIN connector or USB connector

Mouse	6-pin mini-DIN connector or USB connector
USB	four USB-compliant connectors
Audio ⁷	three miniature connectors for line-in, line-out, and microphone
Internally accessible:	
Primary EIDE channel	40-pin connector on PCI local bus
Secondary EIDE channel	40-pin connector on PCI local bus
Floppy drive	34-pin connector
⁷ Present only on computers with integrated audio capabilities.	

Video	
Video controller	Intel 3D AGP graphics

Audio²	
Audio controller	ADI 1885
² Present only on computers with integrated audio capabilities.	

Controls and Lights	
Power control	push button
Power light	green light on power button—blinking green in sleep state; solid green for power on state
Hard-drive access light	green
Diagnostic code lights	four bicolor (amber and green) located on back panel

Power	
DC power supply:	
Wattage	145 W
Heat dissipation	495 BTU (fully loaded computer without monitor)
Voltage (switch-selectable on back panel)	90 to 135 V at 60 Hz; 180 to 265 V at 50 Hz; 100 V at 50 to 60 Hz for Japanese computers <i>NOTE: The voltage selection switch must be set to the 115V position even though the AC supply in Japan is 100 V.</i>
Backup battery	3-V CR2032 coin cell

Physical	
Height x Width x Depth	39 x 16.8 x 34 cm (15.375 x 6.625 x 13.375 inches)
Weight	9.9 Kg (22 lbs)

Environmental	
Temperature:	
Operating	10° to 35°C (50° to 95°F) ³
Storage	-40° to 65°C (-40° to 149°F)
Relative humidity	20% to 80% (noncondensing)
Maximum vibration:	
Operating	0.25 G at 3 to 200 Hz at 1/2 octave/min
Storage	0.5 G at 3 to 200 Hz at 1/2 octave/min
Maximum shock:	
Operating	bottom half-sine pulse with a change in velocity of 50.8 cm/sec (20 inches/sec)
Storage	23-G faired-square wave with a velocity change of 508 cm/sec (200 inches/sec)
Altitude:	
Operating	-15.2 to 3048 m (-50 to 10,000 ft) ³
Storage	-15.2 to 10,600 m (-50 to 35,000 ft)
³ At 35°C (95°F), the maximum operating altitude is 914 m (3000 ft).	

[Back to Contents Page](#)

System Setup Program

Dell™ Dimension™ 2200

- [Overview](#)
- [Viewing Settings](#)
- [Clearing Forgotten Passwords](#)

Overview

The system setup program contains the standard settings for your computer.

NOTICE: Unless you are an expert computer user, don't change the settings for this program. Certain changes might make your computer work incorrectly.

See the following figure for an example of the main screen of the program.

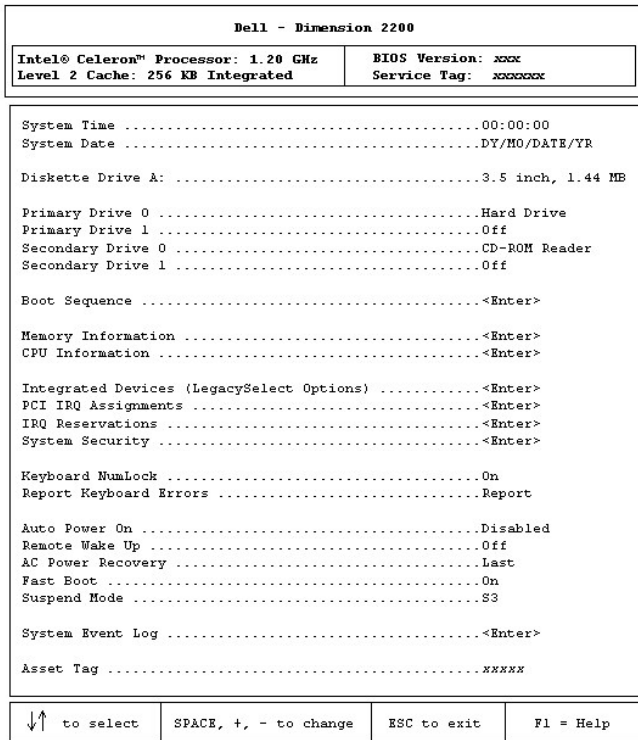

Viewing Settings

1. Turn on (or restart) your computer.
2. When the blue DELL™ logo appears, press <F2> immediately.

If you wait too long and the operating system logo appears, continue to wait until you see the Microsoft® Windows® desktop. Then shut down your computer and try again.

System Setup Program Screens

The system setup program screens display the current configuration information for your computer. Information on the screen is divided into five areas:

1. Title – The area at the top of all system setup screens that displays your computer's model number.

- 1 Computer data – Two boxes below the title that display the system processor, L2 cache, service tag, and the version number of the system setup program.
- 1 Options – A scrollable box listing options that define the configuration of your computer (including installed hardware, power conservation, and security features).

Fields to the right of the listed options contain settings or values. The settings and values that you can change are brighter on the screen. All other settings and values are set by the computer and cannot be changed. When <Enter> appears to the right of an option, press <Enter> to access a pop-up menu of additional options.

- 1 Key functions – A line of boxes across the bottom of all system setup screens that lists keys and their functions within the system setup program.
- 1 Help – Press <F1> for information on the option that is selected (highlighted).

Option	Function
System Time	Displays the system time.
System Date	Displays the system date.
Diskette Drive A:	Displays floppy drive details.
Primary Drive 0:	Displays primary hard drive 0. The default is Auto .
Primary Drive 1:	Displays primary hard drive 1 (if installed). The default is Off .
Secondary Drive 0:	Displays secondary hard drive 0. The default is Auto .
Secondary Drive 1:	Displays secondary hard drive device type. The default is Off .
Boot Sequence	Displays boot sequence when <Enter> is pressed.
Memory Information	Displays amount of system memory.
CPU Information	Displays CPU information when <Enter> is pressed.
Integrated Devices (Legacy Select Options)	Displays integrated device options when <Enter> is pressed.
PCI IRQ Assignments	Displays PCI IRQ assignments when <Enter> is pressed.
IRQ Reservations	Displays the IRQ reservations when <Enter> is pressed.
System Security	Displays system security options when <Enter> is pressed.
Keyboard Numlock	Turns the Keyboard NumLock option on and off. The default is On .
Report Keyboard Errors	Displays keyboard errors when set to Report . The default is Report .
Auto Power On	Allows auto power-on. The default is Disabled .
Remote Wake Up	Allows remote Wake on LAN. The default is Off .
AC Power Recovery	Enables AC power recovery to occur. The default is Last .
Fast Boot	Turns the fast boot option on and off. The default is Off .
Suspend Mode	Displays the suspend state used by the computer. The default is S3 .
System Event Log	Displays the system event log when <Enter> is pressed.
Asset Tag	Displays asset tag information.

The following table shows **CPU Information** option information.

Option	Function
CPU Speed	Sets the CPU speed. The default is Normal .
Bus Speed	Displays the bus speed.
Processor ID	Displays processor ID.
Clock Speed	Displays clock speed.
Cache Size	Displays cache size.

The following table shows **Integrated Devices (Legacy Select Options)** information.

Option	Function
Sound	Turns the integrated sound off and on. The default is On .
Mouse Port	Turns the mouse port off and on. The default is On .
USB Emulation	Turns USB emulation off and on. The default is On .
USB Controller	Turns the USB controller off and on. The default is On .
Serial Port 1	Sets serial port options and turns the port off and on. The default is Auto .
Parallel Port	Displays parallel port settings when <Enter> is pressed. The default mode is PS/2 and the I/O address default is 378h .
IDE Drive Interface	Sets the IDE drive interface options. The default is Auto .
Diskette Interface	Sets floppy drive interface options. The default is Auto .
PC Speaker	Turns the PC speaker off and on. The default is On .
Primary Video Controller	Sets the primary video controller. The default is AGP .

Video DAC Snoop	Turns the video DAC Snoop off and on. The default is Off .
-----------------	---

The following table shows **System Security** option information.

Option	Function
Password Status	Locks and unlocks the password option. The default is Unlocked .
System Password	Enables and disables the system password. The default is Disabled .
Setup Password	Enables and disables the setup password. The default is Disabled .
PXE BIS Default Policy	Specifies how the computer will respond to boot integrity services authentication requests when no certificate has been installed. When set to Deny (the default), this request is rejected. The request is accepted when set to Accept .

Clearing Forgotten Passwords

 **CAUTION:** Before you begin any of the procedures in this section, follow the safety instructions in "[Safety Instructions](#)."

If you forget your system or setup password, you cannot operate your computer or change settings in the system setup program until you clear the forgotten password(s).

 **NOTICE:** This process erases both the system and setup passwords.

1. [Shut down the computer](#).
2. Turn off any attached devices and disconnect them from their electrical outlets.

 **NOTICE:** To disconnect a network cable, first unplug the cable from your computer and then unplug it from the network wall jack.

3. Disconnect the computer power cable from the wall outlet, and then press the power button to ground the system board.
4. [Remove the computer cover](#).
5. Locate jumper [PSWD on the system board](#) and remove the jumper plug.
6. [Replace the computer cover](#), plug your computer into an electrical outlet, and turn on the computer.

The existing password(s) are erased.

7. [Shut down the computer](#).
8. Turn off any attached devices and disconnect them from their electrical outlets.

 **NOTICE:** To disconnect a network cable, first unplug the cable from your computer and then unplug it from the network wall jack.

9. Disconnect the computer power cable from the wall outlet, and then press the power button to ground the system board.
10. [Remove the computer cover](#).
11. Install the PSWD jumper plug.
12. [Replace the computer cover](#), plug your computer into an electrical outlet, and turn on the computer.

Turning on your computer with the PSWD jumper installed reenables the password feature.

[Back to Contents Page](#)

[Back to Contents Page](#)

Technical Overview

Dell™ Dimension™ 2200

- [Internal View](#)
 - [System Board Connectors and Sockets](#)
 - [Power Supply](#)
 - [DC Power Connectors](#)
-

Internal View

⚠ CAUTION: Before you begin any of the procedures in this section, read "[Safety Instructions](#)."

🔍 NOTICE: Be careful when [removing the computer cover](#) to ensure that you do not inadvertently disconnect cables from the system board.

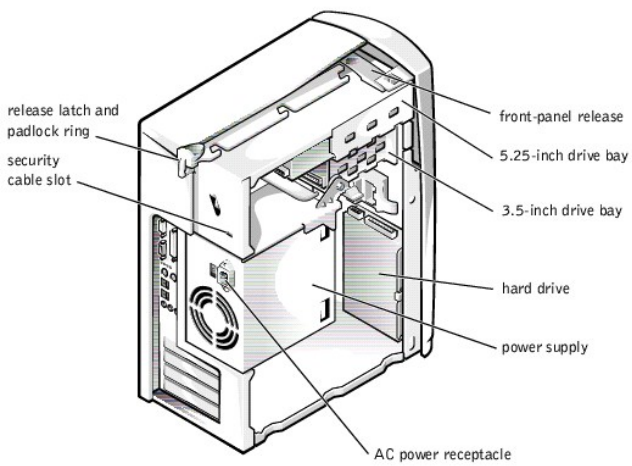

System Board Connectors and Sockets

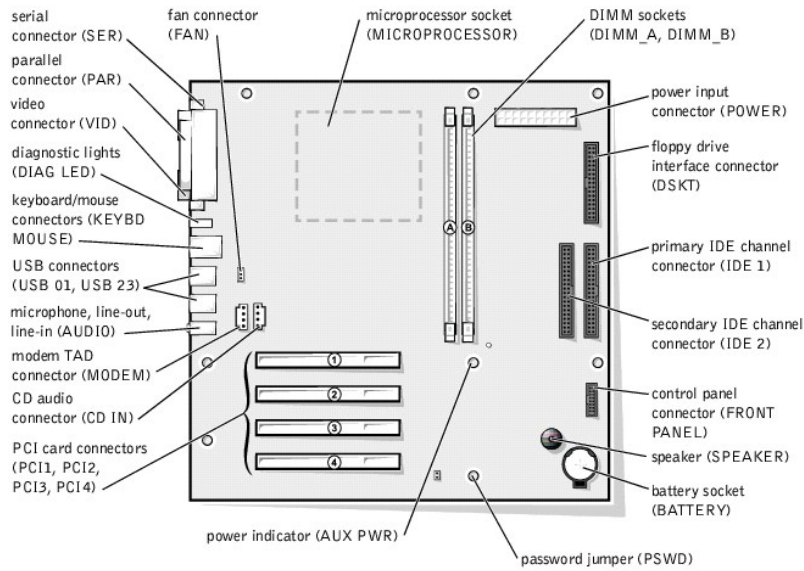

Power Supply

The 145-W power supply can operate from an AC power source of 115 VAC at 60 Hz or 230 VAC at 50 Hz. The power supply provides the DC operating voltages and currents listed in the following table.

Output Voltage ¹	Regulation	Minimum Current (A)	Maximum Current (A) ²
+12 VDC	+/-5%	0.0	4.5
+5 VDC	+/-5%	1.0	16.0
+3.3 VDC	+/-5%	0.1/0.0 ³	10.0
-5 VDC	+/-10%	0.0	0.3
-12 VDC	+/-10%	0.0	0.3
+5 VFP	+/-5%	0.0	1.2

¹Outputs meet and do not exceed SELV requirements per electrical standards (UL 1950, IEC 950, or EN60950 Par. 2.3).

²Maximum continuous combined load on +5 VDC and +3.3 VDC outputs do not exceed 85 W.

³In system configurations where +3.3 VDC is not used, all other outputs stay within regulation while the +3.3 VDC output is in a zero load condition.

DC Power Connectors

Power Supply DC Connector Pin Assignments

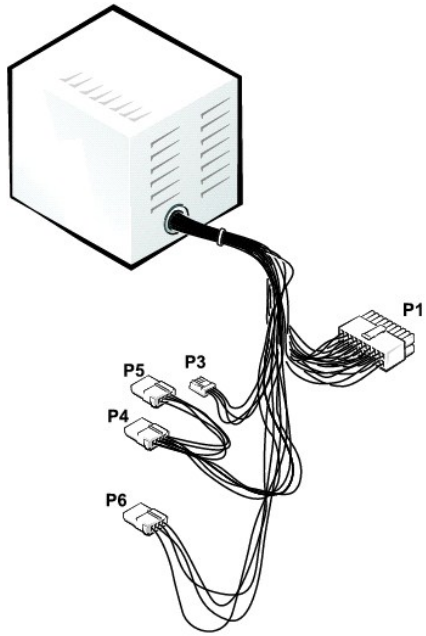

DC Power Connector P1

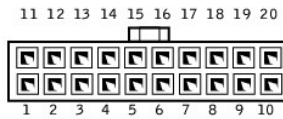

Pin Number	Signal name	18-AWG Wire
1	+3.3 VDC	Orange
2	+3.3 VDC	Orange
3	COM	Black
4	+5 VDC	Red
5	COM	Black
6	+5 VDC	Red
7	COM	Black
8	POK	Gray
9	+5 VFP	Purple
10	+12 VDC	Yellow
11	+3.3 VDC ¹	Orange/brown
12	-12 VDC	Blue
13	COM	Black
14	PS ON	Green
15	COM	Black
16	COM	Black
17	COM	Black
18	N/C	N/C
19	+5 VDC	Red
20	+5 VDC	Red

¹Default sense signal must be consistent with the Intel output specification.

DC Power Connector P3

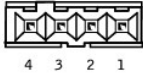

Pin Number	Signal Name	22-AWG Wire
1	+5 VDC	Red
2	COM	Black
3	COM	Black
4	+12 VDC	Yellow

DC Power Connectors P4, P5, and P6

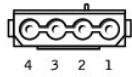

Pin Number	Signal Name	18-AWG Wire
1	+12 VDC	Yellow
2	COM	Black
3	COM	Black
4	+5 VDC	Red

[Back to Contents Page](#)

Controls and Lights

Dell™ Dimension™ 2200

● [Front View](#)

● [Back View](#)

Front View

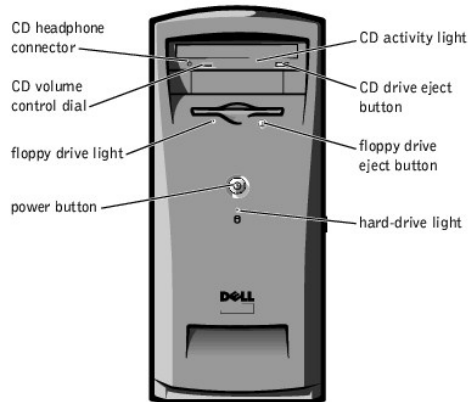

CD Activity Light

The CD activity light is on when the computer reads data from the CD drive.

CD Drive Eject Button

Press this button to eject your CD from the CD drive.

Floppy Drive Eject Button

Press this button to eject a disk from the floppy drive.

Hard-Drive Light

The hard-drive light is on when the computer reads data from or writes data to your hard drive.

Power Button

Press the power button to turn on the computer.

➡ **NOTICE:** To turn off your computer, perform a Windows® shutdown rather than pressing the power button. Otherwise, you may lose data.

Floppy Drive Light

The floppy drive light is on when the computer reads data from or writes data to the floppy drive.

CD Volume Control Dial

Move the dial to adjust the volume of your audio CD.

CD Headphone Connector

Use the CD headphone connector to attach headphones to the CD drive. Audio from the CD headphone connector is enabled only if the CD drive is not operating in digital mode. To disable digital mode:

1. In Microsoft® Windows XP, click the **Start** button, click **Control Panel**, and then double-click **Sounds and Audio Devices**. In Windows 2000, click the **Start** button, point to **Settings**, click **Control Panel**, and then double-click **Sounds and Multimedia**.
2. Click the **Hardware** tab.
3. Double-click the name of your CD drive.
4. Click the **Properties** tab.

5. Uncheck the **Enable digital CD audio for this CD-ROM device box**.
-

Back View

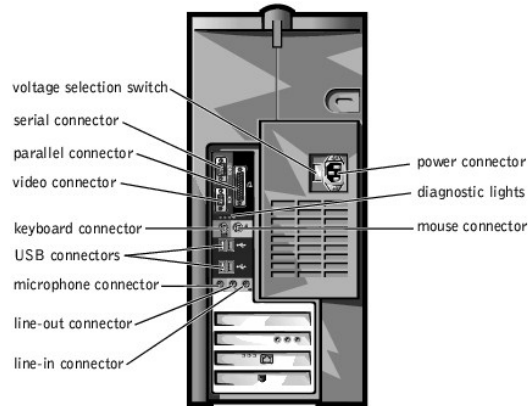

Power Connector

Plug one end of your computer power cable into the power connector, and plug the other end into an electrical outlet.

Diagnostic Lights

These lights display [codes](#) that help you troubleshoot a problem with the computer.

Mouse Connector

Plug a standard mouse into the green mouse connector. If you have a USB mouse, plug it into a USB connector.

Line-In Connector

Use the blue line-in connector (available on computers with integrated sound) to attach a record/playback device such as a cassette player, CD player, or VCR.

On computers with a sound card, the line-in connector is on the card.

Line-Out Connector

Use the green line-out connector (available on computers with integrated sound) to attach headphones and most speakers with integrated amplifiers.

On computers with a sound card, the line-out connector is on the card.

Microphone Connector

Use the pink microphone connector (available on computers with integrated sound) to attach a personal computer microphone for voice or musical input into a sound or telephony program.

On computers with a sound card, the microphone connector is on the card.

USB Connectors

 **HINT:** If you attach a USB device that was not included in your original computer order, you may need to install a specific driver to make the device work. Check the documentation that came with the device or contact the USB device manufacturer for more information.

Connect USB devices, such as USB digital cameras, gaming controllers, and scanners to these connectors.

Keyboard Connector

If you have a standard keyboard, plug the keyboard into the purple keyboard connector. If you have a USB keyboard, plug it into a USB connector.

Video Connector

Plug the cable from your monitor into the blue video connector.

Parallel Connector

Connect a parallel device, such as a printer, to the parallel connector. If you have a USB printer, plug it into a USB connector.

Serial Connector

Connect a serial device, like a handheld device, to the serial connector.

Voltage Selection Switch

See "[Safety Instructions](#)" for voltage setting information.

[Back to Contents Page](#)